

A3.2

MCCB (Easy-Fix) CASSETTES

09/2021

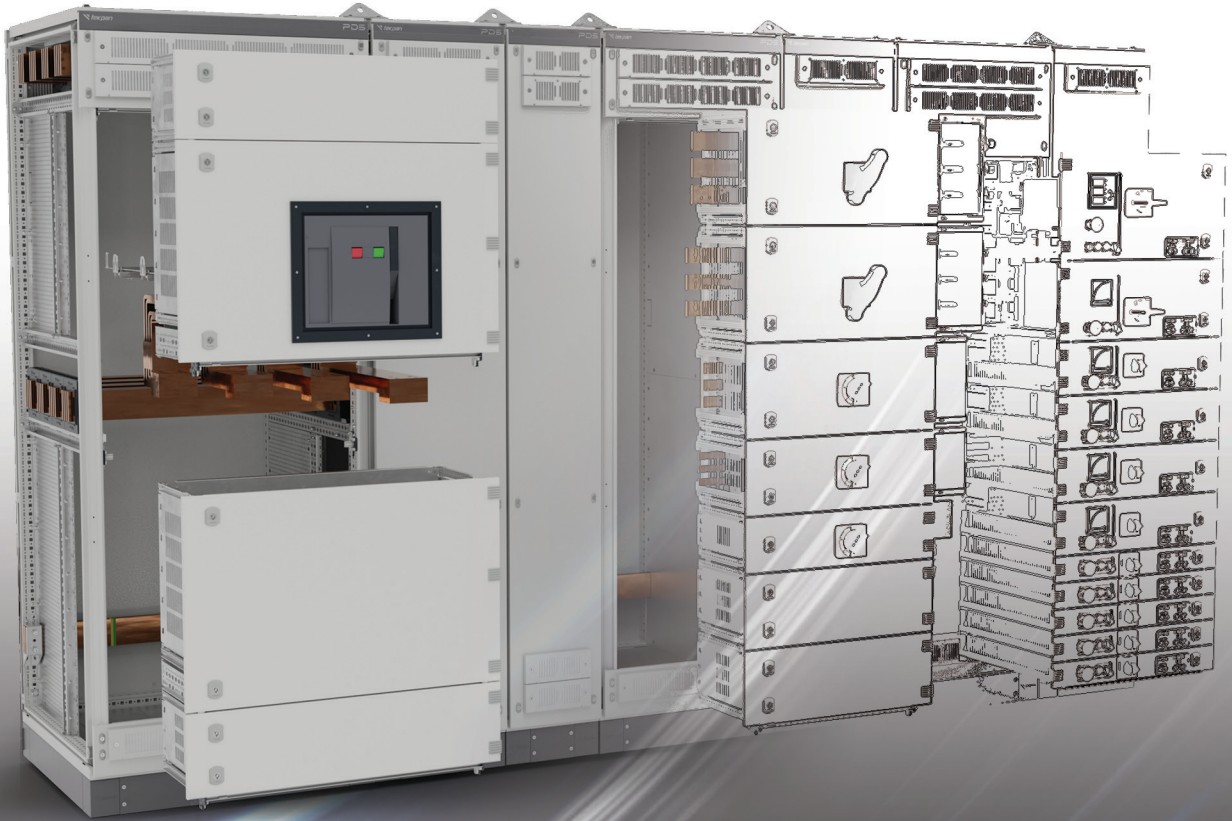

PDS

UPGRADE THE POWER

SELECTION CHARACTERISTICS

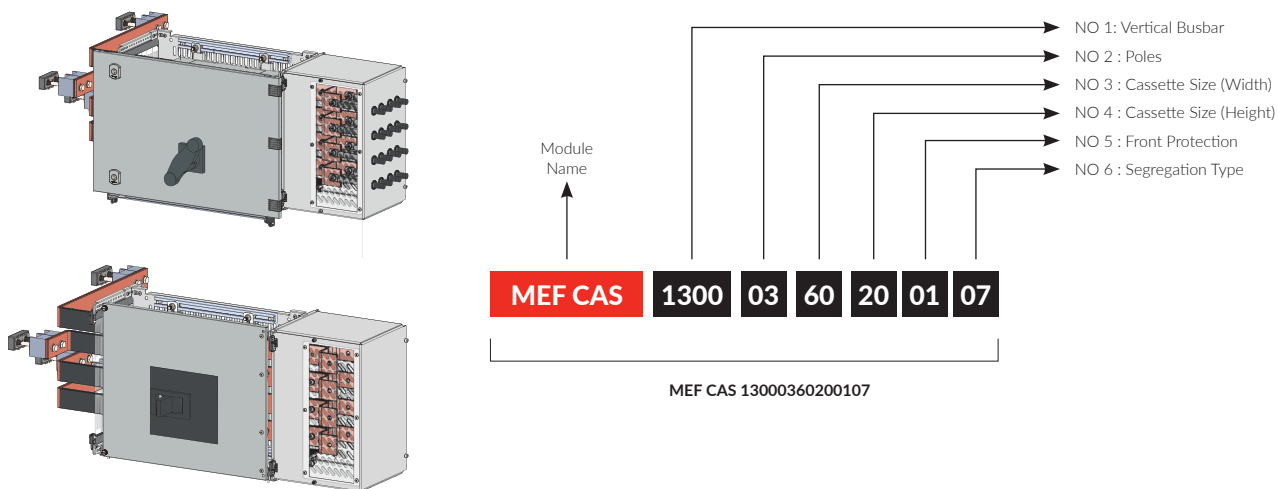

NO 1			NO 2		NO 3		NO 4		NO 5		NO 6			
Selection Code	Vertical Busbar(In)	Module Depth(D)	Selection Code	Poles	Selection Code	Cassette Width(W)	Selection Code	Cassette Height(H)	Selection Code	Front Protection	Selection Code	Segregation Type		
0495	495A	600/800	03	3	40	400	15	150	01	Internal	01	Form 1		
0700	700A	600/800			60	600					20	200	02	Form 2a
0900	900A	600/800			80	800					25	250	03	Form 2b
1100	1100A	600/800			30	300					04	Form 3a		
1300	1300A	600/800			35	350					05	Form 3b		
1350	1350A	600/800			40	400					06	Form 4a		
1620	1620A	600/800			45	450					07	Form 4b		
1860	1860A	600/800												
2300	2300A	600/800												
2500	2500A	800												
3000	3000A	800												
3400	3400A	800												
4000	4000A	800												

CONCEPT OF THE EASY-FIX CASSETTE

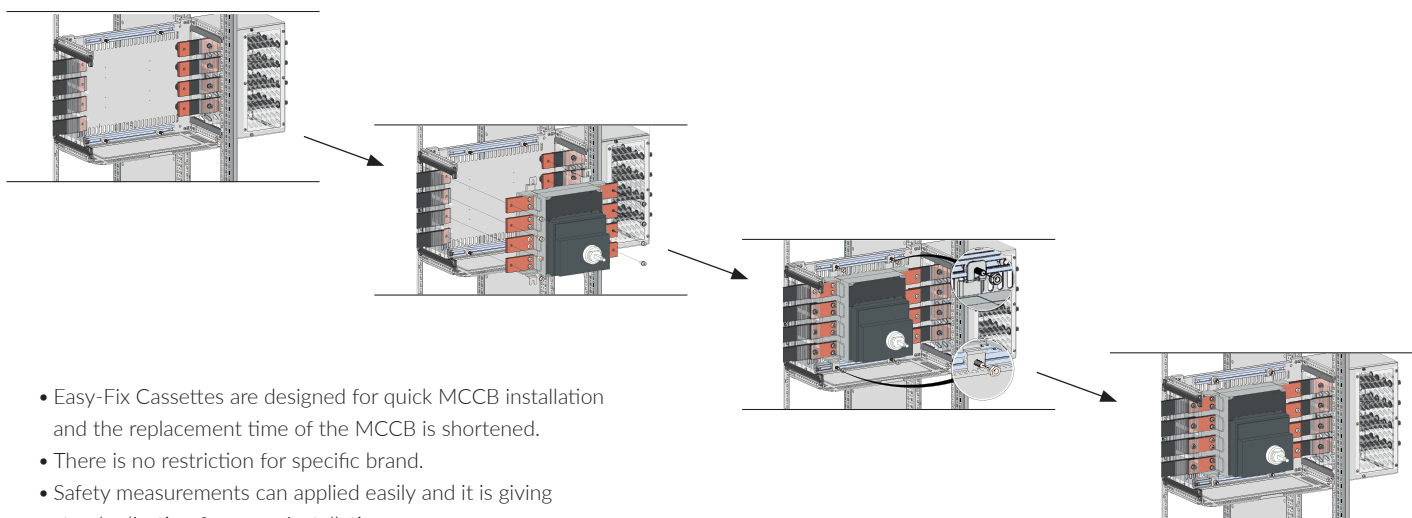

WITH EXTERNAL PARTIAL DOOR

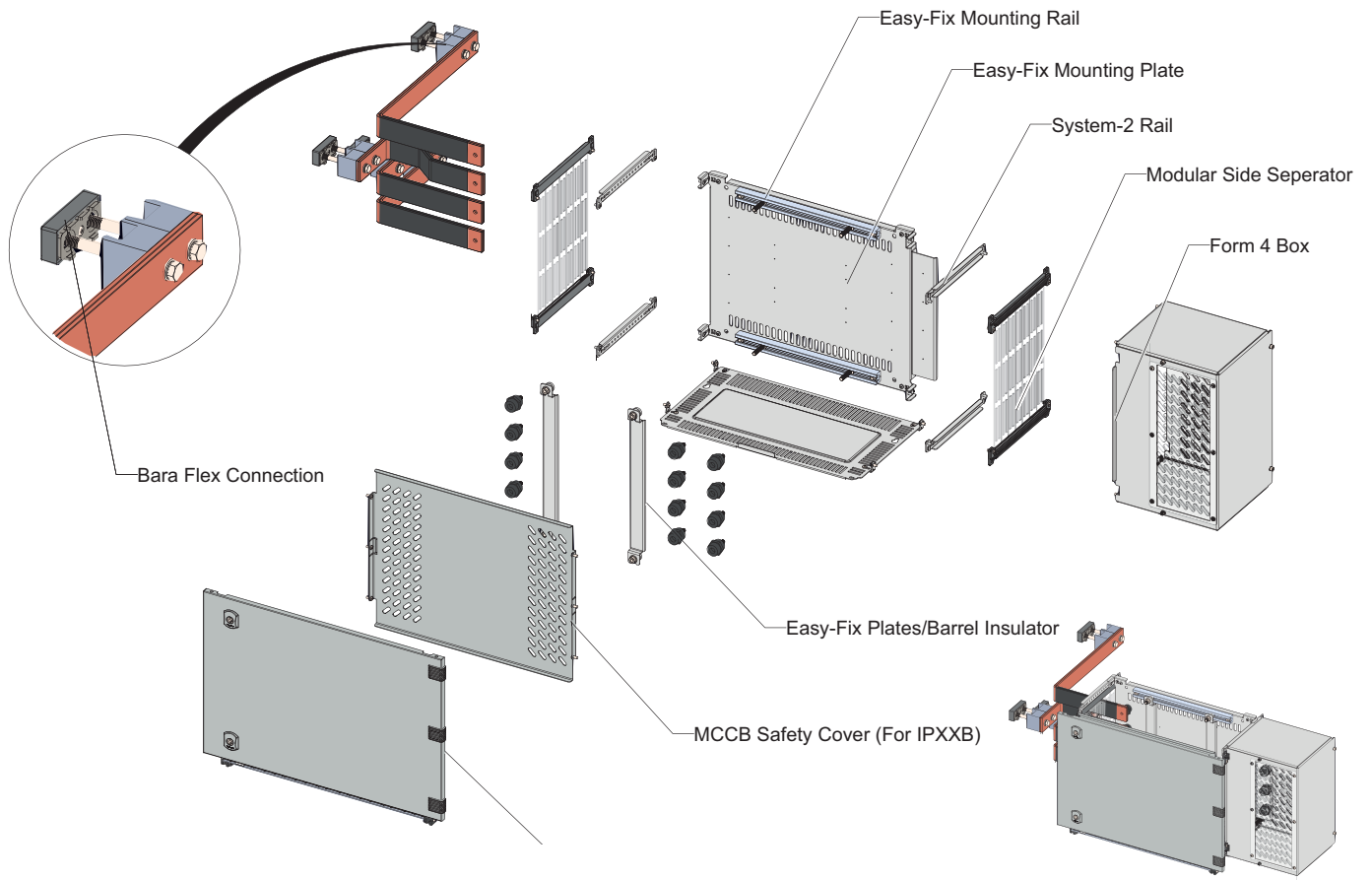

WITH INTERNAL PARTIAL DOOR

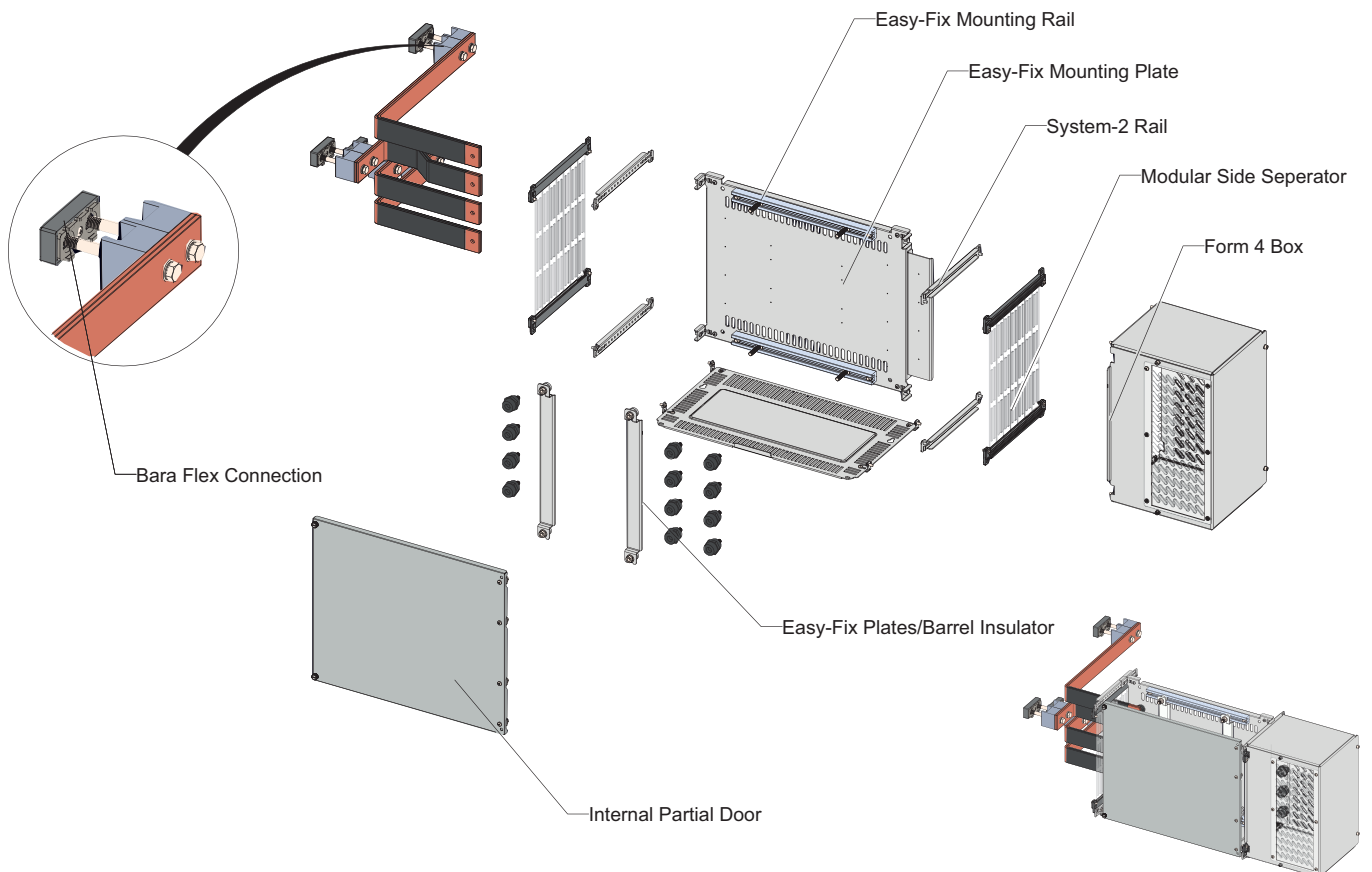

■ NO 1 : CASSETTE SIZE

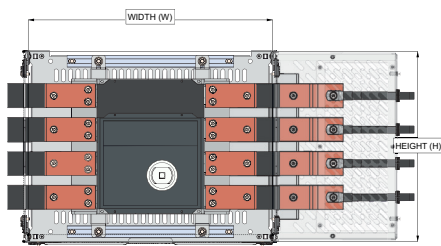
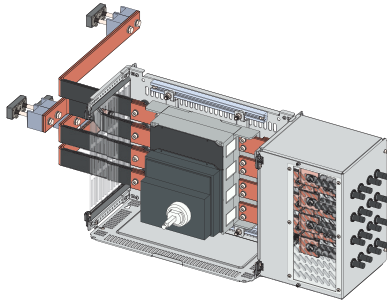

- Cassette sizes depend on size of MCCB's current and poles.
- PDS deliveries cable/conductor connection kits of vertical busbar to cassette. For that reason Pole type selection is important to get the correct quantities.
- When selecting cassettes, the user must to be consider the pole type of the module and pole type of the cassette have to be compatible.

NO BRAND				
MODEL	FUNCTIONAL UNIT CURRENT (A)	POLE	WIDTH(W)*	HEIGHT(H)
UNIVERSAL	250	3	400/600/800	200
	250-630	3/4	400/600/800	250
	400-630	3/4	600/800	300
	630-1600	3	600/800	350
	630-1600	4	600/800	400

SCHNEIDER				
MODEL	FUNCTIONAL UNIT CURRENT (A)	POLE	WIDTH(W)*	HEIGHT(H)
NSX	250	3	400/600/800	200
NSX	250	4	400/600/800	250
NSX	400-630	3	600/800	250
NSX	400-630	4	600/800	300
NS	800-1600	3	600/800	350
NS	800-1600	4	600/800	400

SIEMENS				
MODEL	FUNCTIONAL UNIT CURRENT (A)	POLE	WIDTH(W)*	HEIGHT(H)
3VA2(0,1,2)	250	3	400/600/800	200
3VA2(0,1,2)	250	4	400/600/800	250
3VA2(3,4)	250-630	3	600/800	250
3VA2(3,4)	250-630	4	600/800	300
3VA25	250-1000	3	600/800	350
3VA25	250-1000	4	600/800	400
3VA27	800-1600	3	600/800	350
3VA27	800-1600	4	600/800	400

ABB				
MODEL	FUNCTIONAL UNIT CURRENT (A)	POLE	WIDTH(W)*	HEIGHT(H)
XT3/XT4	250	3	400/600/800	200
XT3/XT4	250	4	400/600/800	250
T5	400-630	3	600/800	250
T5	400-630	4	600/800	300
T6	630-1000	3	600/800	350
T6	630-1000	4	600/800	400
T7	800-1600	3	600/800	350
T7	800-1600	4	600/800	400

■ NO 2: VERTICAL BUSBAR of DISTRIBUTION IN THE MODULE

3 POLES (L1+L2+L3) + N + PE

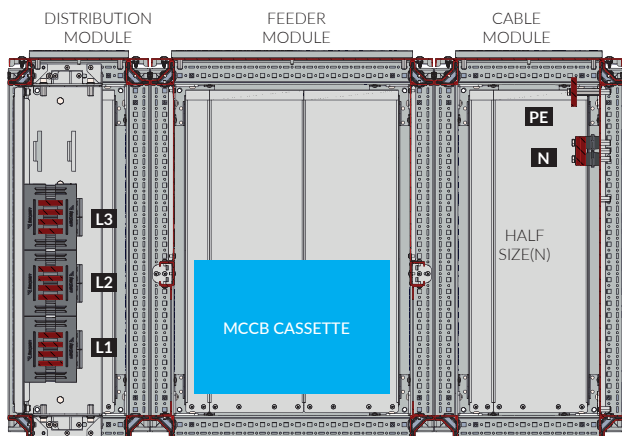

FRONT SURFACE

4 POLES (L1+L2+L3+N) + PE

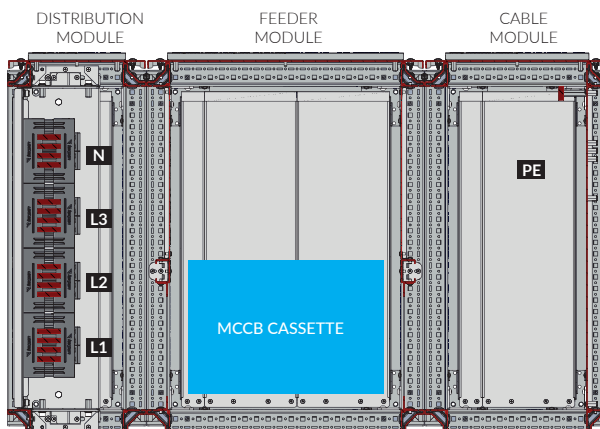

FRONT SURFACE

! Note : 3 Phases vertical busbar position (L1+L2+L3)+N is valid in TN-S(1/2), TN-C (PEN)(1/2), TN-C-S(1/2) and TT(1/2) configurations in NO 3. Please see at Earthing System

! Note : 4 Phases vertical busbar position (L1+L2+L3+N) is valid in only TN-S(1/1) and TT(1/1) configurations in NO 3. Please see at Earthing System

AMBIANCE TEMP : 25°C, HEATING TEMP : 30°C, 50 Hz A.C.			
Module Depth	Rated Current (In)	Flat Copper Size (mm) x Qty	
		L1/L2/L3	Neutral(N)
600D/800D	495A	20/5x2	20/5x2
600D/800D	700A	30/5x2	30/5x2
600D/800D	900A	40/5x2	40/5x2
600D/800D	1100A	50/5x2	50/5x2
600D/800D	1300A	60/5x2	60/5x2
600D/800D	1350A	40/10x2	40/10x2
600D/800D	1620A	50/10x2	50/10x2
600D/800D	1860A	60/10x2	60/10x2
600D/800D	2300A	80/10x2	80/10x2
800D	2500A	40/10x4	40/10x4
800D	3000A	50/10x4	50/10x4
800D	3400A	60/10x4	60/10x4
800D	4000A	80/10x4	80/10x4

- First important selection is Vertical Busbar Type of the module feeding.
- When loading the feeder module with cassettes, the user must to be consider the total power capacity of vertical power with usage factor.
- PDS deliveries cable/conductor connection kits of vertical busbar to cassette. For that reason vertical busbar type and size selection is important to get the correct kit.

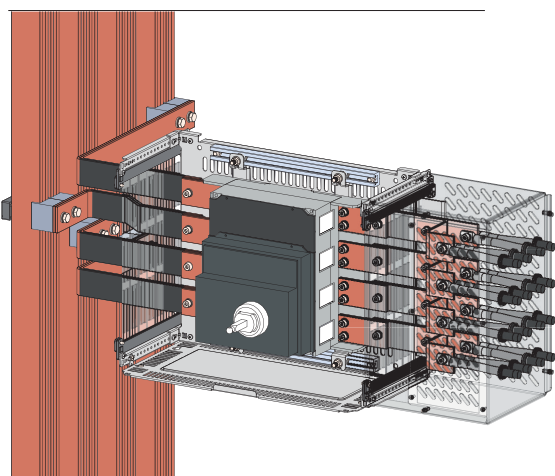

- Second important selection is Pole Type of the cassette feeding.
- There are two type of selection : 3 Poles (L1+L2+L3) +N+PE or 4 Poles (L1+L2+L3+N)+PE as the user demand.
- PDS deliveries cable/conductor connection kits of vertical busbar to cassette. For that reason Pole type selection is important to get the correct quantities.
- When selecting cassettes, the user must to be consider the pole type of the module and pole type of the cassette have to be compatible.
- If user selects 4 poles cassette have to be sure that the module earthing configuration comprises TN-S(1/1) and TT(1/1).

For 3 poles selection the user can be choose all type of earthing configurations. Please see at earthing configuration sheets and instructions.

- The busbar connection kits comprise ;
 - (a) Flex connect busbar nut according to quantities and thickness of flat bars in each pole.
 - (b) Bar connection part works as a conductor and spacer according to quantities and thickness of flat bars in each pole.
 - (c) Hexagon head screw and safety washers according to height of flat bars.

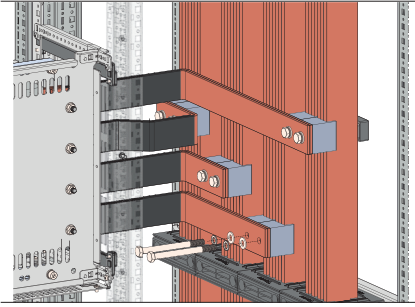

MCCB (A)	Copper Size	Copper Qty.	Hexagon Head Bolt Selection (800D)				Split Lock Washer	Flat Washer
			4000A	3400A	3000A	2500A		
			80/10	60/10	50/10	40/10		
1600A	50/10	2	M10x150	M10x130	M10x120	M10x110	M10	M10
1250A	40/10	2	M10x150	M10x130	M10x120	M10x110	M10	M10
1000A	50/5	2	M10x140	M10x120	M10x110	M10x100	M10	M10
800A	50/10	1	M10x140	M10x120	M10x110	M10x100	M10	M10
630A	30/5	2	M10x140	M10x120	M10x110	M10x100	M10	M10
400A	30/5	1	M10x135	M10x115	M10x105	M10x95	M10	M10
250A	20/5	1	M10x135	M10x115	M10x105	M10x95	M10	M10

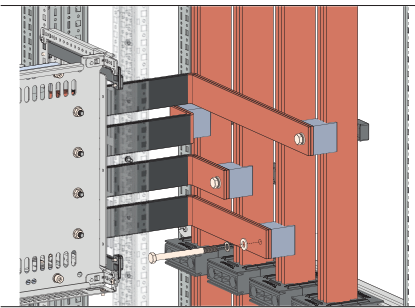

MCCB (A)	Copper Size	Copper Qty.	Hexagon Head Bolt Selection(600D/800D)				Split Lock Washer	Flat Washer
			2300A	1860A	1620A	1350A		
			80/10	60/10	50/10	40/10		
1600A	50/10	2	M8x150	M8x130	M8x120	M8x110	M8	M8
1250A	40/10	2	M8x150	M8x130	M8x120	M8x110	M8	M8
1000A	50/5	2	M8x140	M8x120	M8x110	M8x100	M8	M8
800A	50/10	1	M8x140	M8x120	M8x110	M8x100	M8	M8
630A	30/5	2	M8x140	M8x120	M8x110	M8x100	M8	M8
400A	30/5	1	M8x135	M8x115	M8x105	M8x95	M8	M8
250A	20/5	1	M8x135	M8x115	M8x105	M8x95	M8	M8

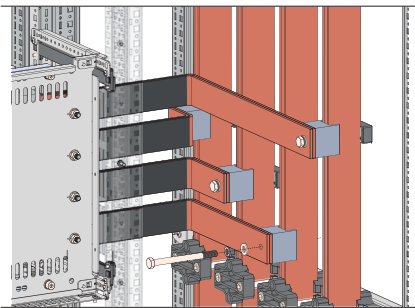

MCCB (A)	Copper Size	Copper Qty.	Hexagon Head Bolt Selection(600D/800D)					Split Lock Washer	Flat Washer
			1300A	1100A	900A	700A	495A		
			60/5	50/5	40/5	30/5	20/5		
1600A	50/10	2	M8x120	M8x110	M8x100	M8x90	M8x80	M8	M8
1250A	40/10	2	M8x120	M8x110	M8x100	M8x90	M8x80	M8	M8
1000A	50/5	2	M8x110	M8x100	M8x90	M8x80	M8x70	M8	M8
800A	50/10	1	M8x110	M8x100	M8x90	M8x80	M8x70	M8	M8
630A	30/5	2	M8x110	M8x100	M8x90	M8x80	M8x70	M8	M8
400A	30/5	1	M8x105	M8x95	M8x85	M8x75	M8x65	M8	M8
250A	20/5	1	M8x105	M8x95	M8x85	M8x75	M8x65	M8	M8

■ NO 3 : SEGREGATION TYPE

Form 1

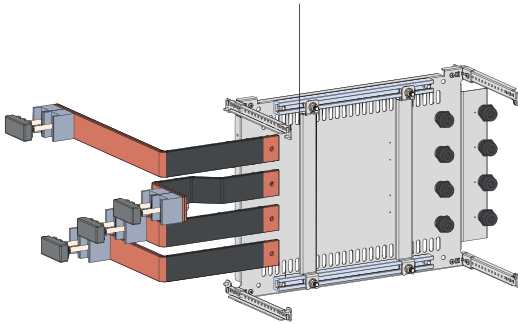

- ! Selecting cassettes, the user must to be consider the segregation of the module and the cassette have to be compatible.
- See the details for assembling cassettes according to Form types in assembling drawings and instructions.

Form 2a

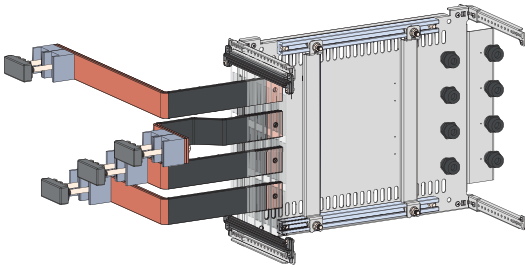

Form 2b

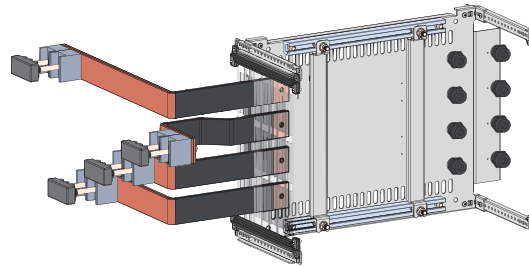

Form 3a

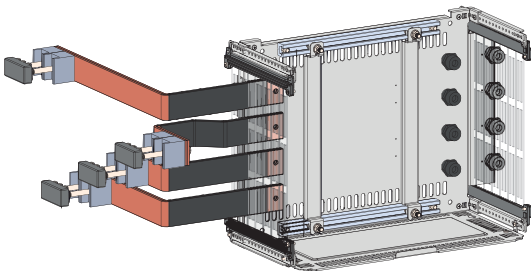

Form 3b

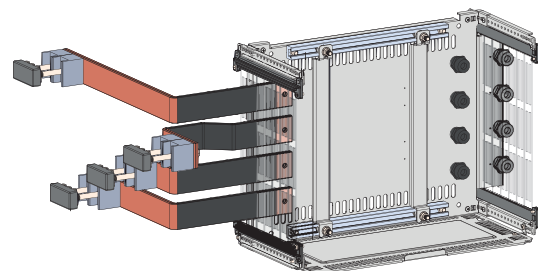

Form 4a

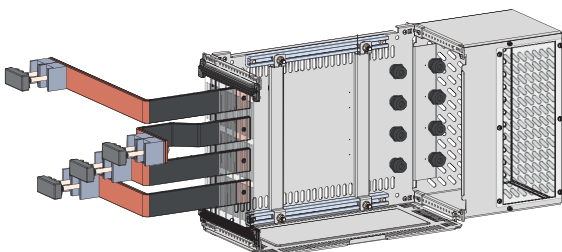

Form 4b

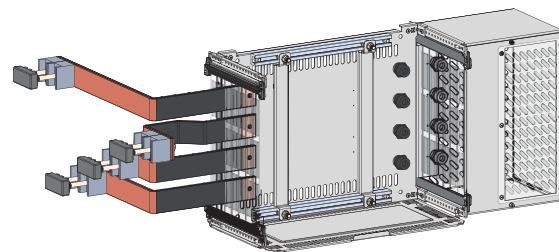

■ NO 4 : FRONT PROTECTION

Internal Protection

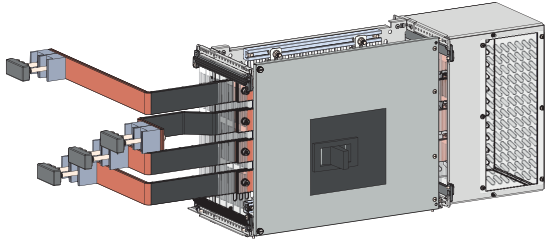

External Protection

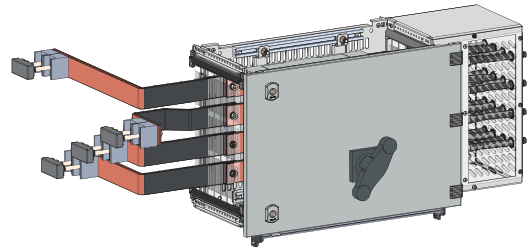

Depth View Size of Internal Protection

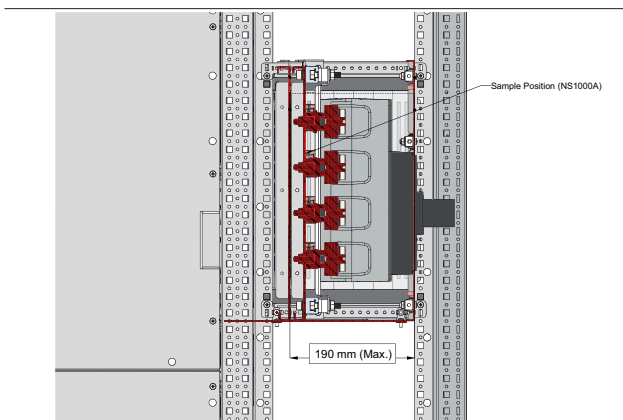

Depth View Size of External Protection

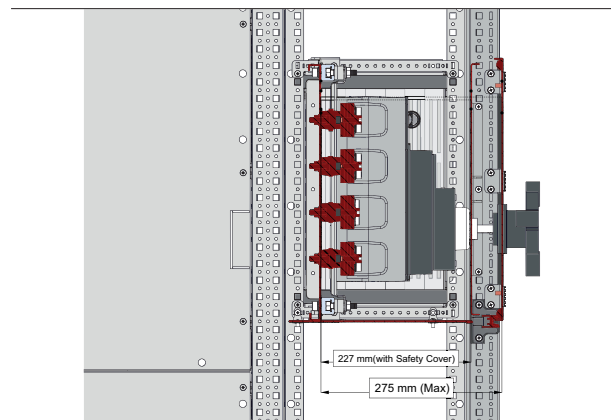

! Selecting cassettes, the user must to be consider the front protection of the module and the cassette have to be compatible.

■ NO : 5 INSTALLATION OF A MCCB CASSETTE

Conductor Connections from Distribution Busbar to MCCB Input

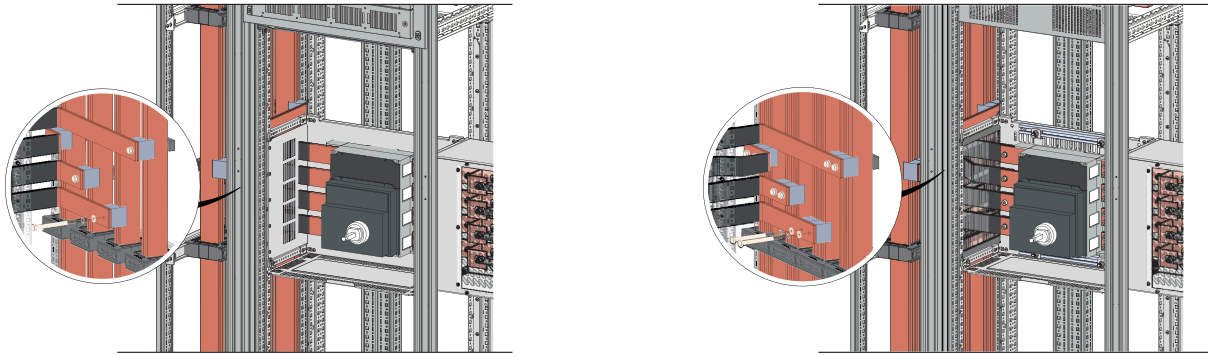

Fixing of an MCCB Cassette into Module

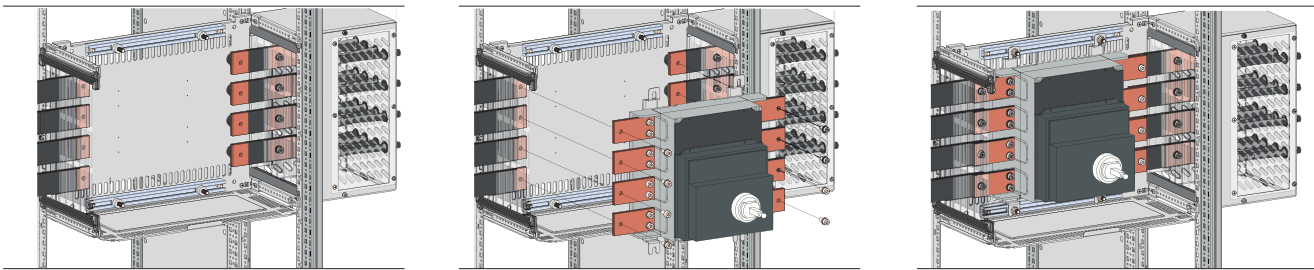

Conductor Connections from MCCB Output to Terminal .

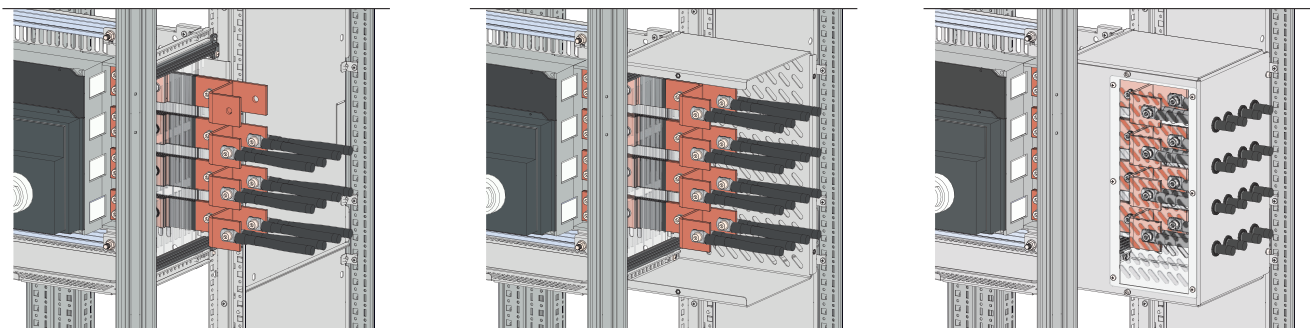



■ 1. SIZING THE CASSETTE

NO BRAND				
MODEL	FUNCTIONAL UNIT CURRENT (A)	POLE	WIDTH(W)*	HEIGHT(H)
UNIVERSAL	250	3	400/600/800	200
	250-630	3/4	400/600/800	250
	400-630	3/4	600/800	300
	630-1600	3	600/800	350
	630-1600	4	600/800	400

SCHNEIDER				
MODEL	FUNCTIONAL UNIT CURRENT (A)	POLE	WIDTH(W)*	HEIGHT(H)
NSX	250	3	400/600/800	200
NSX	250	4	400/600/800	250
NSX	400-630	3	600/800	250
NSX	400-630	4	600/800	300
NS	800-1600	3	600/800	350
NS	800-1600	4	600/800	400

ABB				
MODEL	FUNCTIONAL UNIT CURRENT (A)	POLE	WIDTH(W)*	HEIGHT(H)
XT3/XT4	250	3	400/600/800	200
XT3/XT4	250	4	400/600/800	250
T5	400-630	3	600/800	250
T5	400-630	4	600/800	300
T6	630-1000	3	600/800	350
T6	630-1000	4	600/800	400
T7	800-1600	3	600/800	350
T7	800-1600	4	600/800	400

SIEMENS				
MODEL	FUNCTIONAL UNIT CURRENT (A)	POLE	WIDTH(W)*	HEIGHT(H)
3VA2(0,1,2)	250	3	400/600/800	200
3VA2(0,1,2)	250	4	400/600/800	250
3VA2(3,4)	250-630	3	600/800	250
3VA2(3,4)	250-630	4	600/800	300
3VA25	250-1000	3	600/800	350
3VA25	250-1000	4	600/800	400
3VA27	800-1600	3	600/800	350
3VA27	800-1600	4	600/800	400



2. MCCB MOUNTING SYSTEM

2.1 SYSTEM-2 FRAME

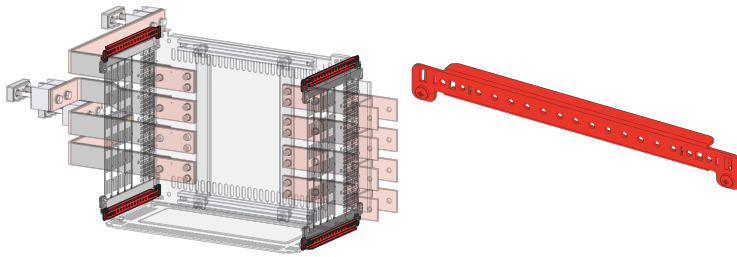

REF. NO.	PACKAGE QTY. (pcs)	REQUIRED QTY. (pcs.)
1037.001	4 pcs.	4

● **Please compare** the required quantities with the packs of ordering codes.

2.2 EASY-FIX MOUNTING PLATE

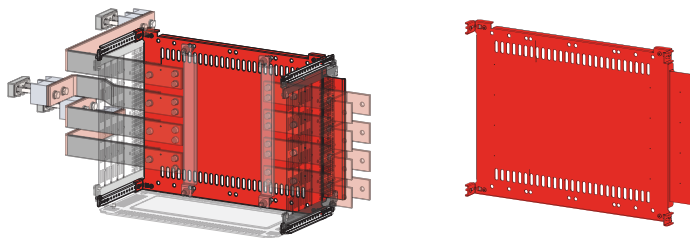

● **Please compare** the required quantities with the packs of ordering codes.

WIDTH(W)	HEIGHT(H)	REF. NO.	PACKAGE QTY. (pcs)	REQUIRED QTY. (pcs.)
400	200	1045.420	1 pc.	1
400	250	1045.425	1 pc.	1
400	300	1045.430	1 pc.	1
400	350	1045.435	1 pc.	1
400	400	1045.440	1 pc.	1
600	200	1045.620	1 pc.	1
600	250	1045.625	1 pc.	1
600	300	1045.630	1 pc.	1
600	350	1045.635	1 pc.	1
600	400	1045.640	1 pc.	1
800	200	1045.820	1 pc.	1
800	250	1045.825	1 pc.	1
800	300	1045.830	1 pc.	1
800	350	1045.835	1 pc.	1
800	400	1045.840	1 pc.	1

2.3 EASY-FIX MOUNTING PROFILE

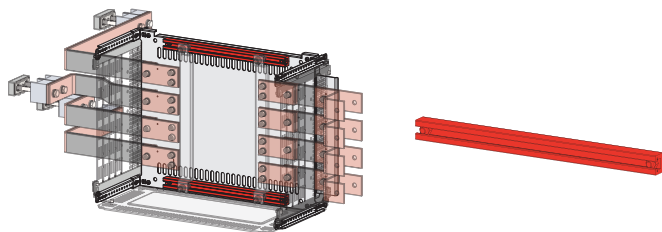

HEIGHT(H)	REF. NO.	PACKAGE QTY. (set)	REQUIRED QTY.(set)
200	1039.200	1 set.	1
250-400	1039.300	1 set.	1

● **(1 Set= 2 pcs.)**

● **Please compare** the required quantities with the packs of ordering codes.

2.4 EASY-FIX MOUNTING RAIL KIT

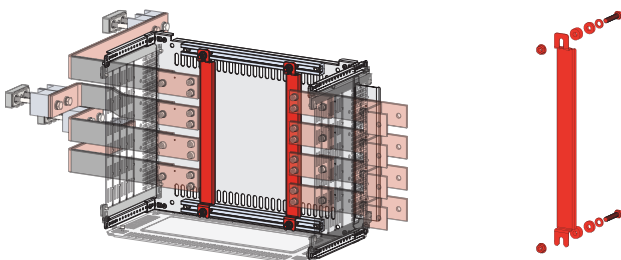

HEIGHT(H)	REF. NO.	PACKAGE QTY. (set)	REQUIRED QTY.(set)
200	1039.020	1 set.	1
250	1039.025	1 set.	1
300	1039.030	1 set.	1
350	1039.035	1 set.	1
400	1039.040	1 set.	1

● **(1 Set= 2 pcs.)**

● **Please compare** the required quantities with the packs of ordering codes.

2.5 EASY-FIX BARREL INSULATOR

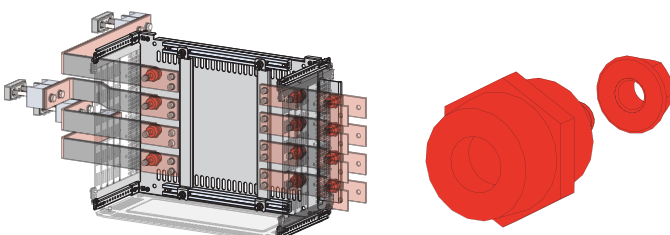

POLE	REF. NO.	PACKAGE QTY. (pcs)	REQUIRED QTY. (pcs.)
3	1040.001	1 set.	1
4	1040.002	1 set.	1

● **(1 Set= 2 pcs.)**

● **Please compare** the required quantities with the packs of ordering codes.



■ 3. SEPARATION

■ 3.1 SIDE SEPARATION

■ 3.1.1 MODULAR SIDE SEPARATION COVER

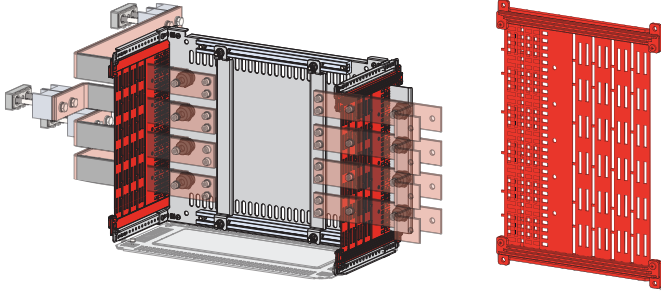

HEIGHT(H)	REF. NO.	PACKAGE QTY. (pcs)	REQUIRED QTY. (pcs.)
200	1039.020	1 pc.	1/2**
250	1039.025	1 pc.	1/2**
300	1039.030	1 pc.	1/2**
350	1039.035	1 pc.	1/2**
400	1039.040	1 pc.	1/2**

- **Please compare** the required quantities with the packs of ordering codes.
- **MODULAR SIDE SEPARATION COVER** must be selected only if it is necessary.
- 1 pieces required with **Form 2b, Form 4a** separating options.
- 2 pieces required with **Form 2a, Form 3a, Form 3b, Form 4b** separating options.

■ 3.1.2 SIDE SEPARATION COVER

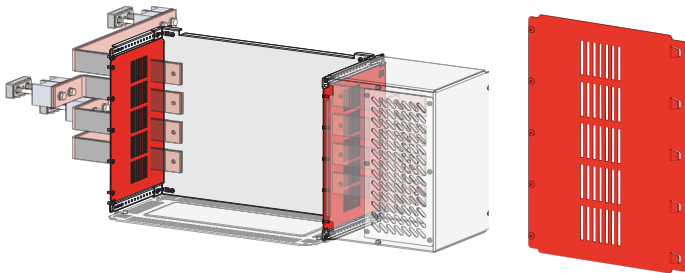

HEIGHT(H)	REF. NO.	PACKAGE QTY. (pcs)	REQUIRED QTY. (pcs.)
200	1033.200	1 pc.	1/2**
250	1033.250	1 pc.	1/2**
300	1033.300	1 pc.	1/2**
350	1033.350	1 pc.	1/2**
400	1033.400	1 pc.	1/2**

- **Please compare** the required quantities with the packs of ordering codes.
- **MODULAR SIDE SEPARATION COVER** must be selected only if it is necessary.
- 1 pieces required with **Form 2b, Form 4a** separating options.
- 2 pieces required with **Form 2a, Form 3a, Form 3b, Form 4b** separating options.



■ 3.2 MCCB BOTTOM SEPARATION SHELF

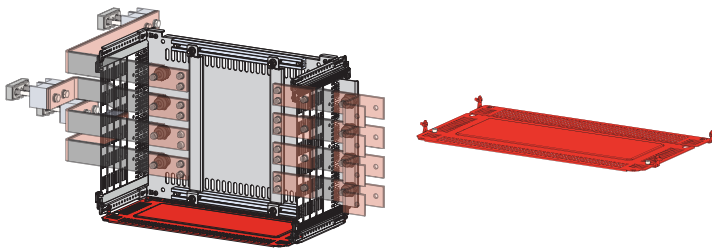

HEIGHT(H)	REF. NO.	PACKAGE QTY. (pcs)	REQUIRED QTY. (pcs.)
400	1032.040	1 pc.	1
600	1032.060	1 pc.	1
800	1032.080	1 pc.	1

- **MCCB BOTTOM SEPARATION SHELF** must be selected with **Form 3a, Form 3b, Form 4a, Form 4b** separating options.
- **Please compare** the required quantities with the packs of ordering codes.

■ 3.3 FORM 4 SEPARATION BOX

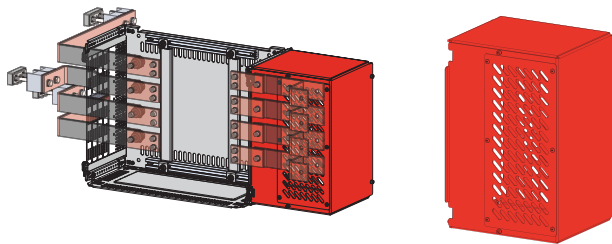

HEIGHT(H)	REF. NO.	PACKAGE QTY. (pcs)	REQUIRED QTY. (pcs.)
200	1042.020	1 pc.	1
250	1042.025	1 pc.	1
300	1042.030	1 pc.	1
350	1042.035	1 pc.	1
400	1042.040	1 pc.	1

- **FORM 4 SEPARATION BOX** must be selected with **Form 4a, Form 4b** separating options.
- **Please compare** the required quantities with the packs of ordering codes.



■ 4.FRONT DOOR

■ 4.1 EXTERNAL PARTIAL DOOR

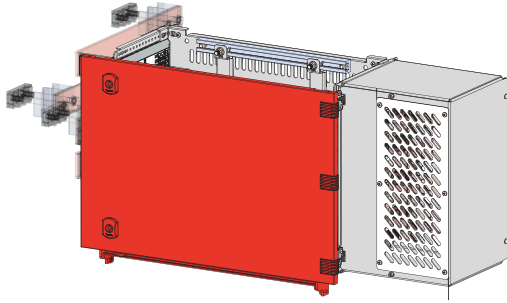

WIDTH(W)	HEIGHT(H)	REF. NO.	PACKAGE QTY. (pcs)	REQUIRED QTY. (pcs.)
400	200	853.420	1 pc.	1
400	250	853.425	1 pc.	1
400	300	853.430	1 pc.	1
400	350	853.435	1 pc.	1
400	400	853.440	1 pc.	1
600	200	853.620	1 pc.	1
600	250	853.625	1 pc.	1
600	300	853.630	1 pc.	1
600	350	853.635	1 pc.	1
600	400	853.640	1 pc.	1
800	200	853.820	1 pc.	1
800	250	853.825	1 pc.	1
800	300	853.830	1 pc.	1
800	350	853.835	1 pc.	1
800	400	853.840	1 pc.	1

● **EXTERNAL DOOR** must be selected only if it is necessary.

■ 4.2 MCCB SAFETY COVER

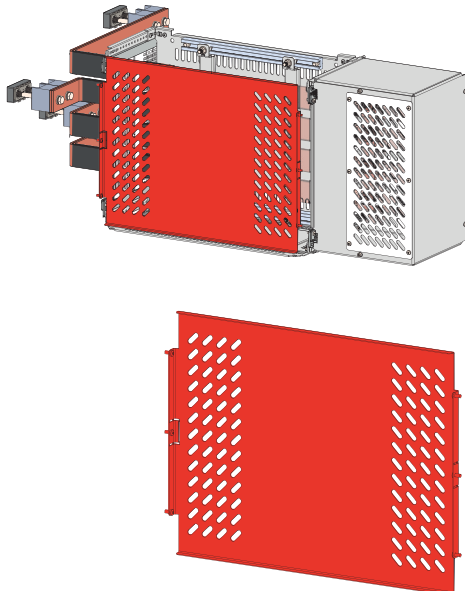

WIDTH(W)	HEIGHT(H)	REF. NO.	PACKAGE QTY. (pcs)	REQUIRED QTY. (pcs.)
400	200	1064.420	1 pc.	1
400	250	1064.425	1 pc.	1
400	300	1064.430	1 pc.	1
400	350	1064.435	1 pc.	1
400	400	1064.440	1 pc.	1
600	200	1064.620	1 pc.	1
600	250	1064.625	1 pc.	1
600	300	1064.630	1 pc.	1
600	350	1064.635	1 pc.	1
600	400	1064.640	1 pc.	1
800	200	1064.820	1 pc.	1
800	250	1064.825	1 pc.	1
800	300	1064.830	1 pc.	1
800	350	1064.835	1 pc.	1
800	400	1064.840	1 pc.	1

- This part can be used with **EXTERNAL PARTIAL DOOR**.
- **MCCB SAFETY COVER** could be selected with **Form 4a, Form 4b** separating options.
- **Please compare** the required quantities with the packs of ordering codes.



■ 4.3 INTERNAL PARTIAL DOOR

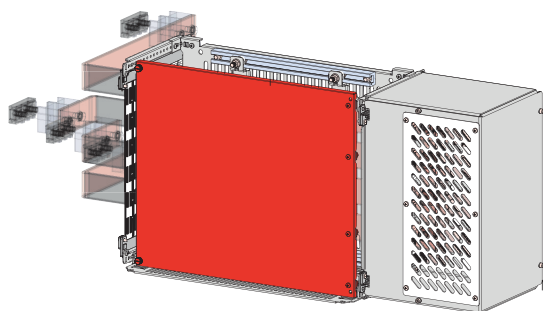

WIDTH(W)	HEIGHT(H)	REF. NO.	PACKAGE QTY. (pcs)	REQUIRED QTY. (pcs.)
400	200	954.420	1 pc.	1
400	250	954.425	1 pc.	1
400	300	954.430	1 pc.	1
400	350	954.435	1 pc.	1
400	400	954.440	1 pc.	1
600	200	954.620	1 pc.	1
600	250	954.625	1 pc.	1
600	300	954.630	1 pc.	1
600	350	954.635	1 pc.	1
600	400	954.640	1 pc.	1
800	200	954.820	1 pc.	1
800	250	954.825	1 pc.	1
800	300	954.830	1 pc.	1
800	350	954.835	1 pc.	1
800	400	954.840	1 pc.	1

● **INTERNAL DOOR** must be selected only if it is necessary.



5. VERTICAL BUSBAR CONNECTION

5.1 VERTICAL BUSBAR CONNECTION KIT (2500A-4000A)

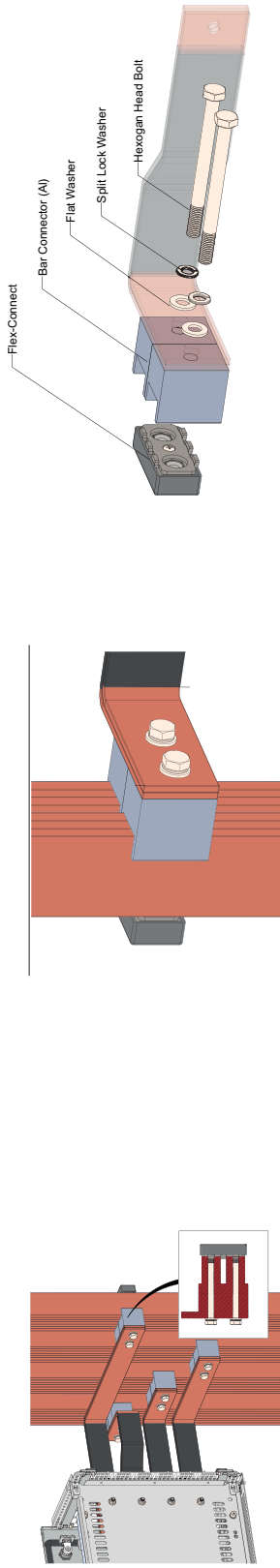

VERTICAL BUSBAR(A)	MCCB BAR SIZE		BAR CONNECTION				FLEX-CONNECT				BOLT SIZE				FLAT WASHER				SPLIT LOCK WASHER			
	TYPE	QTY	REF. NO.	PACK QTY (pcs)	REQUIRED QTY (pcs) (L1, L2, L3)	REQUIRED QTY (pcs.) (N)	REF. NO.	PACK QTY (pcs)	REQUIRED QTY (pcs) (L1, L2, L3)	REQUIRED QTY (pcs.) (N)	REF. NO.	PACK QTY (pcs)	REQUIRED QTY (pcs) (L1, L2, L3)	REQUIRED QTY (pcs.) (N)	REF. NO.	PACK QTY (pcs)	REQUIRED QTY (pcs) (L1, L2, L3)	REQUIRED QTY (pcs.) (N)	REF. NO.	PACK QTY (pcs)	REQUIRED QTY (pcs) (L1, L2, L3)	REQUIRED QTY (pcs.) (N)
4000	50/10	2	1051.050	1 pc.	6	2	1035.001	20 pcs.	3	1	1054.150	20 pcs.	6	2	1035.201	20 pcs.	6	2	1035.211	20 pcs.	6	2
4000	40/10	2	1051.040	1 pc.	6	2	1035.001	20 pcs.	3	1	1054.150	20 pcs.	6	2	1035.201	20 pcs.	6	2	1035.211	20 pcs.	6	2
4000	50/10	1	1051.050	1 pc.	6	2	1035.001	20 pcs.	3	1	1054.140	20 pcs.	6	2	1035.201	20 pcs.	6	2	1035.211	20 pcs.	6	2
4000	40/10	1	1051.040	1 pc.	6	2	1035.001	20 pcs.	3	1	1054.140	20 pcs.	6	2	1035.201	20 pcs.	6	2	1035.211	20 pcs.	6	2
4000	50/5	2	1051.050	1 pc.	6	2	1035.001	20 pcs.	3	1	1054.140	20 pcs.	6	2	1035.201	20 pcs.	6	2	1035.211	20 pcs.	6	2
4000	40/5	2	1051.040	1 pc.	6	2	1035.001	20 pcs.	3	1	1054.140	20 pcs.	6	2	1035.201	20 pcs.	6	2	1035.211	20 pcs.	6	2
4000	30/5	2	1051.030	1 pc.	6	2	1035.001	20 pcs.	3	1	1054.140	20 pcs.	6	2	1035.201	20 pcs.	6	2	1035.211	20 pcs.	6	2
4000	20/5	2	1051.020	1 pc.	6	2	1035.001	20 pcs.	3	1	1054.140	20 pcs.	6	2	1035.201	20 pcs.	6	2	1035.211	20 pcs.	6	2
4000	50/5	1	1051.050	1 pc.	6	2	1035.001	20 pcs.	3	1	1054.140	20 pcs.	6	2	1035.201	20 pcs.	6	2	1035.211	20 pcs.	6	2
4000	40/5	1	1051.040	1 pc.	6	2	1035.001	20 pcs.	3	1	1054.140	20 pcs.	6	2	1035.201	20 pcs.	6	2	1035.211	20 pcs.	6	2
4000	30/5	1	1051.030	1 pc.	6	2	1035.001	20 pcs.	3	1	1054.140	20 pcs.	6	2	1035.201	20 pcs.	6	2	1035.211	20 pcs.	6	2
4000	20/5	1	1051.020	1 pc.	6	2	1035.001	20 pcs.	3	1	1054.140	20 pcs.	6	2	1035.201	20 pcs.	6	2	1035.211	20 pcs.	6	2

● Please compare the required quantities with the packs of ordering codes.



■ 5.1 VERTICAL BUSBAR CONNECTION KIT (2500A-4000A)

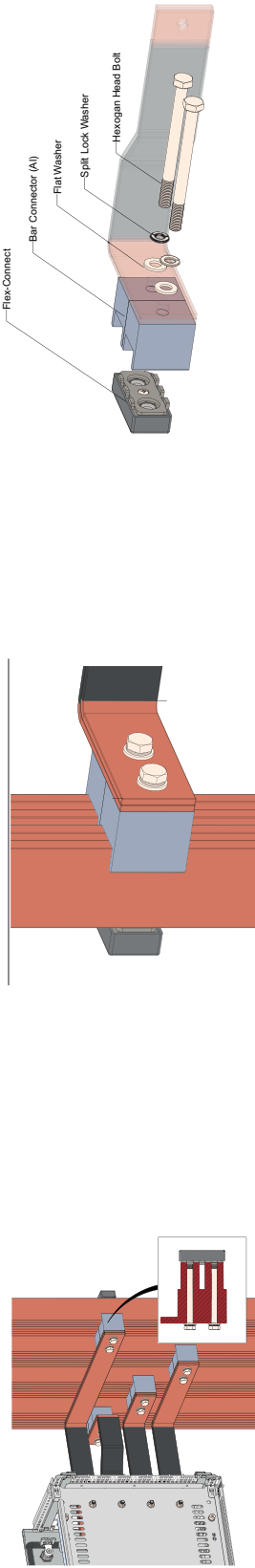

VERTICAL BUSBAR(A)	MCCB BAR SIZE		BAR CONNECTION				FLEX-CONNECT				BOLT SIZE				FLAT WASHER				SPLIT LOCK WASHER			
	TYPE	QTY	REF. NO.	PACK QTY. (pcs)	REQUIRED QTY. (pcs) (L1, L2, L3)	REQUIRED QTY. (pcs) (N)	REF. NO.	PACK QTY. (pcs)	REQUIRED QTY. (pcs) (L1, L2, L3)	REQUIRED QTY. (pcs) (N)	REF. NO.	PACK QTY. (pcs)	REQUIRED QTY. (pcs) (L1, L2, L3)	REQUIRED QTY. (pcs) (N)	REF. NO.	PACK QTY. (pcs)	REQUIRED QTY. (pcs) (L1, L2, L3)	REQUIRED QTY. (pcs) (N)	REF. NO.	PACK QTY. (pcs)	REQUIRED QTY. (pcs) (L1, L2, L3)	REQUIRED QTY. (pcs) (N)
3400	50/10	2	1051.050	1 pc.	6	2	1035.001	20 pcs.	3	1	1054.130	20 pcs.	6	2	1035.201	20 pcs.	6	2	1035.211	20 pcs.	6	2
3400	40/10	2	1051.040	1 pc.	6	2	1035.001	20 pcs.	3	1	1054.130	20 pcs.	6	2	1035.201	20 pcs.	6	2	1035.211	20 pcs.	6	2
3400	50/10	1	1051.050	1 pc.	6	2	1035.001	20 pcs.	3	1	1054.120	20 pcs.	6	2	1035.201	20 pcs.	6	2	1035.211	20 pcs.	6	2
3400	40/10	1	1051.040	1 pc.	6	2	1035.001	20 pcs.	3	1	1054.120	20 pcs.	6	2	1035.201	20 pcs.	6	2	1035.211	20 pcs.	6	2
3400	50/5	2	1051.050	1 pc.	6	2	1035.001	20 pcs.	3	1	1054.120	20 pcs.	6	2	1035.201	20 pcs.	6	2	1035.211	20 pcs.	6	2
3400	40/5	2	1051.040	1 pc.	6	2	1035.001	20 pcs.	3	1	1054.120	20 pcs.	6	2	1035.201	20 pcs.	6	2	1035.211	20 pcs.	6	2
3400	30/5	2	1051.030	1 pc.	6	2	1035.001	20 pcs.	3	1	1054.120	20 pcs.	6	2	1035.201	20 pcs.	6	2	1035.211	20 pcs.	6	2
3400	20/5	2	1051.020	1 pc.	6	2	1035.001	20 pcs.	3	1	1054.120	20 pcs.	6	2	1035.201	20 pcs.	6	2	1035.211	20 pcs.	6	2
3400	50/5	1	1051.050	1 pc.	6	2	1035.001	20 pcs.	3	1	1054.120	20 pcs.	6	2	1035.201	20 pcs.	6	2	1035.211	20 pcs.	6	2
3400	40/5	1	1051.040	1 pc.	6	2	1035.001	20 pcs.	3	1	1054.120	20 pcs.	6	2	1035.201	20 pcs.	6	2	1035.211	20 pcs.	6	2
3400	30/5	1	1051.030	1 pc.	6	2	1035.001	20 pcs.	3	1	1054.120	20 pcs.	6	2	1035.201	20 pcs.	6	2	1035.211	20 pcs.	6	2
3400	20/5	1	1051.020	1 pc.	6	2	1035.001	20 pcs.	3	1	1054.120	20 pcs.	6	2	1035.201	20 pcs.	6	2	1035.211	20 pcs.	6	2

● Please compare the required quantities with the packs of ordering codes.



5.1 VERTICAL BUSBAR CONNECTION KIT (2500A-4000A)

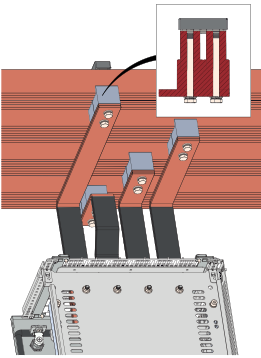
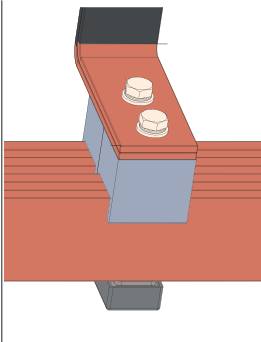
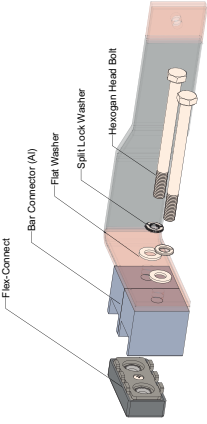

VERTICAL BUSBAR(A)	MCCB BAR SIZE		BAR CONNECTION				FLEX-CONNECT				BOLT SIZE				FLAT WASHER				SPLIT LOCK WASHER			
	TYPE	QTY	REF. NO.	PACK. QTY. (pcs)	REQUIRED QTY. (pcs.) (L1, L2, L3)	REQUIRED QTY. (pcs.) (N)	REF. NO.	PACK. QTY. (pcs)	REQUIRED QTY. (pcs.) (L1, L2, L3)	REQUIRED QTY. (pcs.) (N)	REF. NO.	PACK. QTY. (pcs)	REQUIRED QTY. (pcs.) (L1, L2, L3)	REQUIRED QTY. (pcs.) (N)	REF. NO.	PACK. QTY. (pcs)	REQUIRED QTY. (pcs.) (L1, L2, L3)	REQUIRED QTY. (pcs.) (N)	REF. NO.	PACK. QTY. (pcs)	REQUIRED QTY. (pcs.) (L1, L2, L3)	REQUIRED QTY. (pcs.) (N)
3000	50/10	2	1051.050	1 pc.	6	2	1035.001	20 pcs.	3	1	1054.120	20 pcs.	6	2	1035.201	20 pcs.	6	2	1035.211	20 pcs.	6	2
3000	40/10	2	1051.040	1 pc.	6	2	1035.001	20 pcs.	3	1	1054.120	20 pcs.	6	2	1035.201	20 pcs.	6	2	1035.211	20 pcs.	6	2
3000	50/10	1	1051.050	1 pc.	6	2	1035.001	20 pcs.	3	1	1054.110	20 pcs.	6	2	1035.201	20 pcs.	6	2	1035.211	20 pcs.	6	2
3000	40/10	1	1051.040	1 pc.	6	2	1035.001	20 pcs.	3	1	1054.110	20 pcs.	6	2	1035.201	20 pcs.	6	2	1035.211	20 pcs.	6	2
3000	50/5	2	1051.050	1 pc.	6	2	1035.001	20 pcs.	3	1	1054.110	20 pcs.	6	2	1035.201	20 pcs.	6	2	1035.211	20 pcs.	6	2
3000	40/5	2	1051.040	1 pc.	6	2	1035.001	20 pcs.	3	1	1054.110	20 pcs.	6	2	1035.201	20 pcs.	6	2	1035.211	20 pcs.	6	2
3000	30/5	2	1051.030	1 pc.	6	2	1035.001	20 pcs.	3	1	1054.110	20 pcs.	6	2	1035.201	20 pcs.	6	2	1035.211	20 pcs.	6	2
3000	20/5	2	1051.020	1 pc.	6	2	1035.001	20 pcs.	3	1	1054.110	20 pcs.	6	2	1035.201	20 pcs.	6	2	1035.211	20 pcs.	6	2
3000	50/5	1	1051.050	1 pc.	6	2	1035.001	20 pcs.	3	1	1054.110	20 pcs.	6	2	1035.201	20 pcs.	18	6	1035.211	20 pcs.	6	2
3000	40/5	1	1051.040	1 pc.	6	2	1035.001	20 pcs.	3	1	1054.110	20 pcs.	6	2	1035.201	20 pcs.	18	6	1035.211	20 pcs.	6	2
3000	30/5	1	1051.030	1 pc.	6	2	1035.001	20 pcs.	3	1	1054.110	20 pcs.	6	2	1035.201	20 pcs.	18	6	1035.211	20 pcs.	6	2
3000	20/5	1	1051.020	1 pc.	6	2	1035.001	20 pcs.	3	1	1054.110	20 pcs.	6	2	1035.201	20 pcs.	18	6	1035.211	20 pcs.	6	2

● Please compare the required quantities with the packs of ordering codes.



■ 5.1 VERTICAL BUSBAR CONNECTION KIT (2500A-4000A)

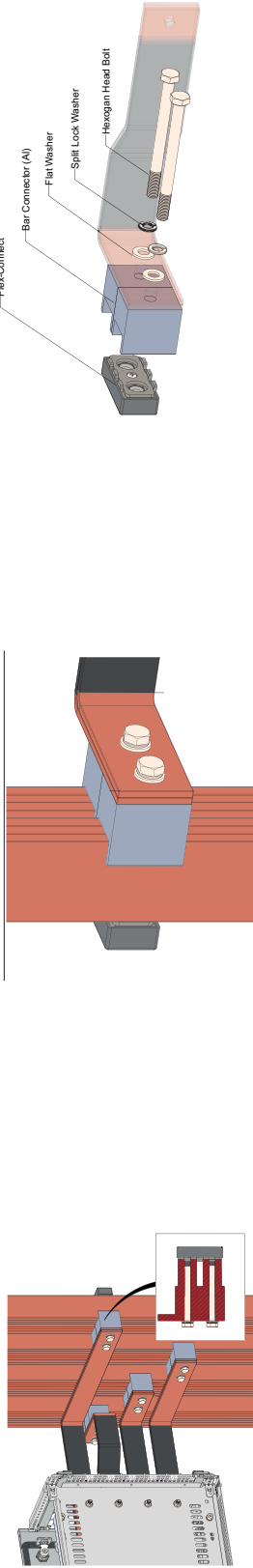

VERTICAL BUSBAR(A)	MCCB BAR SIZE		BAR CONNECTION				FLEX-CONNECT				BOLT SIZE				FLAT WASHER				SPLIT LOCK WASHER			
	TYPE	QTY	REF. NO.	PACK QTY. (pcs)	REQUIRED QTY. (pcs) (L1, L2, L3)	REQUIRED QTY. (pcs) (N)	REF. NO.	PACK QTY. (pcs)	REQUIRED QTY. (pcs) (L1, L2, L3)	REQUIRED QTY. (pcs) (N)	REF. NO.	PACK QTY. (pcs)	REQUIRED QTY. (pcs) (L1, L2, L3)	REQUIRED QTY. (pcs) (N)	REF. NO.	PACK QTY. (pcs)	REQUIRED QTY. (pcs) (L1, L2, L3)	REQUIRED QTY. (pcs) (N)	REF. NO.	PACK QTY. (pcs)	REQUIRED QTY. (pcs) (L1, L2, L3)	REQUIRED QTY. (pcs) (N)
2500	50/10	2	1051.050	1 pc.	6	2	1035.001	20 pcs.	3	1	1054.110	20 pcs.	6	2	1035.201	20 pcs.	6	2	1035.211	20 pcs.	6	2
2500	40/10	2	1051.040	1 pc.	6	2	1035.001	20 pcs.	3	1	1054.110	20 pcs.	6	2	1035.201	20 pcs.	6	2	1035.211	20 pcs.	6	2
2500	50/10	1	1051.050	1 pc.	6	2	1035.001	20 pcs.	3	1	1054.100	20 pcs.	6	2	1035.201	20 pcs.	6	2	1035.211	20 pcs.	6	2
2500	40/10	1	1051.040	1 pc.	6	2	1035.001	20 pcs.	3	1	1054.100	20 pcs.	6	2	1035.201	20 pcs.	6	2	1035.211	20 pcs.	6	2
2500	50/5	2	1051.050	1 pc.	6	2	1035.001	20 pcs.	3	1	1054.100	20 pcs.	6	2	1035.201	20 pcs.	6	2	1035.211	20 pcs.	6	2
2500	40/5	2	1051.040	1 pc.	6	2	1035.001	20 pcs.	3	1	1054.100	20 pcs.	6	2	1035.201	20 pcs.	6	2	1035.211	20 pcs.	6	2
2500	30/5	2	1051.030	1 pc.	6	2	1035.001	20 pcs.	3	1	1054.100	20 pcs.	6	2	1035.201	20 pcs.	6	2	1035.211	20 pcs.	6	2
2500	20/5	2	1051.020	1 pc.	6	2	1035.001	20 pcs.	3	1	1054.100	20 pcs.	6	2	1035.201	20 pcs.	6	2	1035.211	20 pcs.	6	2
2500	50/5	1	1051.050	1 pc.	6	2	1035.001	20 pcs.	3	1	1054.100	20 pcs.	6	2	1035.201	20 pcs.	6	2	1035.211	20 pcs.	6	2
2500	40/5	1	1051.040	1 pc.	6	2	1035.001	20 pcs.	3	1	1054.100	20 pcs.	6	2	1035.201	20 pcs.	6	2	1035.211	20 pcs.	6	2
2500	30/5	1	1051.030	1 pc.	6	2	1035.001	20 pcs.	3	1	1054.100	20 pcs.	6	2	1035.201	20 pcs.	6	2	1035.211	20 pcs.	6	2
2500	20/5	1	1051.020	1 pc.	6	2	1035.001	20 pcs.	3	1	1054.100	20 pcs.	6	2	1035.201	20 pcs.	6	2	1035.211	20 pcs.	6	2

● Please compare the required quantities with the packs of ordering codes.



5.2 VERTICAL BUSBAR CONNECTION KIT (1350A-2300A)

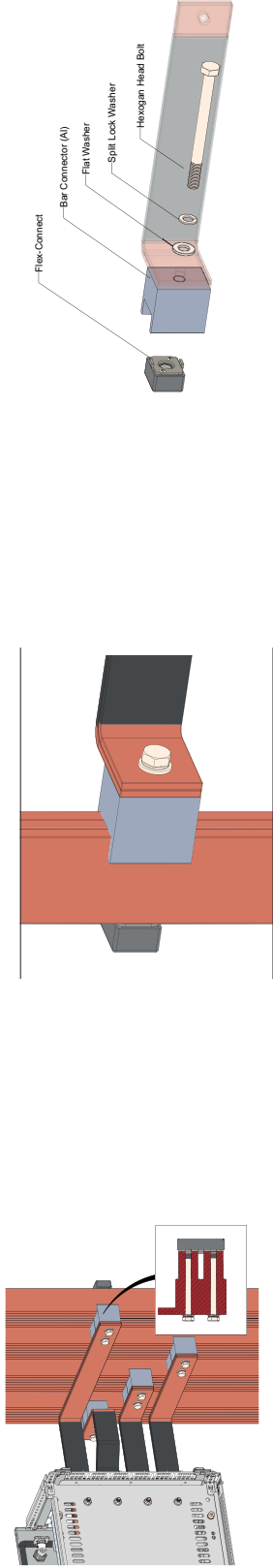

VERTICAL BUSBAR(A)	MCCB BAR SIZE		BAR CONNECTION				FLEX-CONNECT				BOLT SIZE				FLAT WASHER				SPLIT LOCK WASHER			
	TYPE	QTY	REF. NO.	PACK. QTY. (pcs)	REQUIRED QTY. (pcs.) (L1, L2, L3)	REQUIRED QTY. (pcs.) (N)	REF. NO.	PACK. QTY. (pcs)	REQUIRED QTY. (pcs.) (L1, L2, L3)	REQUIRED QTY. (pcs.) (N)	REF. NO.	PACK. QTY. (pcs)	REQUIRED QTY. (pcs.) (L1, L2, L3)	REQUIRED QTY. (pcs.) (N)	REF. NO.	PACK. QTY. (pcs)	REQUIRED QTY. (pcs.) (L1, L2, L3)	REQUIRED QTY. (pcs.) (N)	REF. NO.	PACK. QTY. (pcs)	REQUIRED QTY. (pcs.) (L1, L2, L3)	REQUIRED QTY. (pcs.) (N)
2300	50/10	2	1051.050	1 pc.	3	1	1035.011	40 pcs.	3	1	1035.101	20 pcs.	3	1	1035.111	20 pcs.	3	1	1035.111	20 pcs.	3	1
2300	40/10	2	1051.040	1 pc.	3	1	1035.011	40 pcs.	3	1	1035.101	20 pcs.	3	1	1035.111	20 pcs.	3	1	1035.111	20 pcs.	3	1
2300	50/10	1	1051.050	1 pc.	3	1	1035.011	40 pcs.	3	1	1035.101	20 pcs.	3	1	1035.111	20 pcs.	3	1	1035.111	20 pcs.	3	1
2300	40/10	1	1051.040	1 pc.	3	1	1035.011	40 pcs.	3	1	1035.101	20 pcs.	3	1	1035.111	20 pcs.	3	1	1035.111	20 pcs.	3	1
2300	50/5	2	1051.050	1 pc.	3	1	1035.011	40 pcs.	3	1	1035.101	20 pcs.	3	1	1035.111	20 pcs.	3	1	1035.111	20 pcs.	3	1
2300	40/5	2	1051.040	1 pc.	3	1	1035.011	40 pcs.	3	1	1035.101	20 pcs.	3	1	1035.111	20 pcs.	3	1	1035.111	20 pcs.	3	1
2300	30/5	2	1051.030	1 pc.	3	1	1035.011	40 pcs.	3	1	1035.101	20 pcs.	3	1	1035.111	20 pcs.	3	1	1035.111	20 pcs.	3	1
2300	20/5	2	1051.020	1 pc.	3	1	1035.011	40 pcs.	3	1	1035.101	20 pcs.	3	1	1035.111	20 pcs.	3	1	1035.111	20 pcs.	3	1
2300	50/5	1	1051.050	1 pc.	3	1	1035.011	40 pcs.	3	1	1035.101	20 pcs.	3	1	1035.111	20 pcs.	3	1	1035.111	20 pcs.	3	1
2300	40/5	1	1051.040	1 pc.	3	1	1035.011	40 pcs.	3	1	1035.101	20 pcs.	3	1	1035.111	20 pcs.	3	1	1035.111	20 pcs.	3	1
2300	30/5	1	1051.030	1 pc.	3	1	1035.011	40 pcs.	3	1	1035.101	20 pcs.	3	1	1035.111	20 pcs.	3	1	1035.111	20 pcs.	3	1
2300	20/5	1	1051.020	1 pc.	3	1	1035.011	40 pcs.	3	1	1035.101	20 pcs.	3	1	1035.111	20 pcs.	3	1	1035.111	20 pcs.	3	1

● Please compare the required quantities with the packs of ordering codes.



5.2 VERTICAL BUSBAR CONNECTION KIT (1350A-2300A)

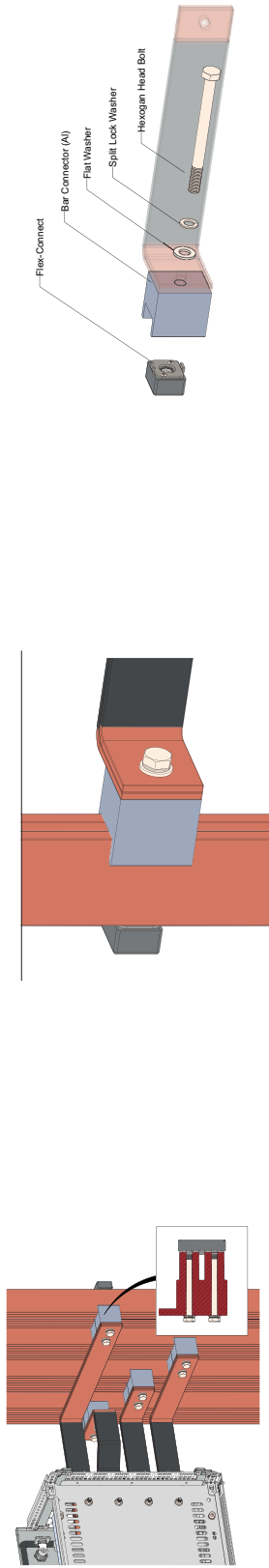

VERTICAL BUSBAR(A)	MCCB BAR SIZE		BAR CONNECTION				FLEX-CONNECT				BOLT SIZE				FLAT WASHER				SPLIT LOCK WASHER			
	TYPE	QTY	REF. NO.	PACK QTY. (pcs)	REQUIRED QTY. (pcs) (L1, L2, L3)	REQUIRED QTY. (pcs) (N)	REF. NO.	PACK QTY. (pcs)	REQUIRED QTY. (pcs) (L1, L2, L3)	REQUIRED QTY. (pcs) (N)	REF. NO.	PACK QTY. (pcs)	REQUIRED QTY. (pcs) (L1, L2, L3)	REQUIRED QTY. (pcs) (N)	REF. NO.	PACK QTY. (pcs)	REQUIRED QTY. (pcs) (L1, L2, L3)	REQUIRED QTY. (pcs) (N)	REF. NO.	PACK QTY. (pcs)	REQUIRED QTY. (pcs) (L1, L2, L3)	REQUIRED QTY. (pcs) (N)
1860	50/10	2	1051.050	1 pc.	3	1	1035.011	40 pcs.	3	1	1053.130	20 pcs.	3	1	1035.101	20 pcs.	3	1	1035.111	20 pcs.	3	1
1860	40/10	2	1051.040	1 pc.	3	1	1035.011	40 pcs.	3	1	1053.130	20 pcs.	3	1	1035.101	20 pcs.	3	1	1035.111	20 pcs.	3	1
1860	50/10	1	1051.050	1 pc.	3	1	1035.011	40 pcs.	3	1	1053.120	20 pcs.	3	1	1035.101	20 pcs.	3	1	1035.111	20 pcs.	3	1
1860	40/10	1	1051.040	1 pc.	3	1	1035.011	40 pcs.	3	1	1053.120	20 pcs.	3	1	1035.101	20 pcs.	3	1	1035.111	20 pcs.	3	1
1860	50/5	2	1051.050	1 pc.	3	1	1035.011	40 pcs.	3	1	1053.120	20 pcs.	3	1	1035.101	20 pcs.	3	1	1035.111	20 pcs.	3	1
1860	40/5	2	1051.040	1 pc.	3	1	1035.011	40 pcs.	3	1	1053.120	20 pcs.	3	1	1035.101	20 pcs.	3	1	1035.111	20 pcs.	3	1
1860	30/5	2	1051.030	1 pc.	3	1	1035.011	40 pcs.	3	1	1053.120	20 pcs.	3	1	1035.101	20 pcs.	3	1	1035.111	20 pcs.	3	1
1860	20/5	2	1051.020	1 pc.	3	1	1035.011	40 pcs.	3	1	1053.120	20 pcs.	3	1	1035.101	20 pcs.	3	1	1035.111	20 pcs.	3	1
1860	50/5	1	1051.050	1 pc.	3	1	1035.011	40 pcs.	3	1	1053.120	20 pcs.	3	1	1035.101	20 pcs.	3	1	1035.111	20 pcs.	3	1
1860	40/5	1	1051.040	1 pc.	3	1	1035.011	40 pcs.	3	1	1053.120	20 pcs.	3	1	1035.101	20 pcs.	3	1	1035.111	20 pcs.	3	1
1860	30/5	1	1051.030	1 pc.	3	1	1035.011	40 pcs.	3	1	1053.120	20 pcs.	3	1	1035.101	20 pcs.	3	1	1035.111	20 pcs.	3	1
1860	20/5	1	1051.020	1 pc.	3	1	1035.011	40 pcs.	3	1	1053.120	20 pcs.	3	1	1035.101	20 pcs.	3	1	1035.111	20 pcs.	3	1

● Please compare the required quantities with the packs of ordering codes.



■ 5.2 VERTICAL BUSBAR CONNECTION KIT (1350A-2300A)

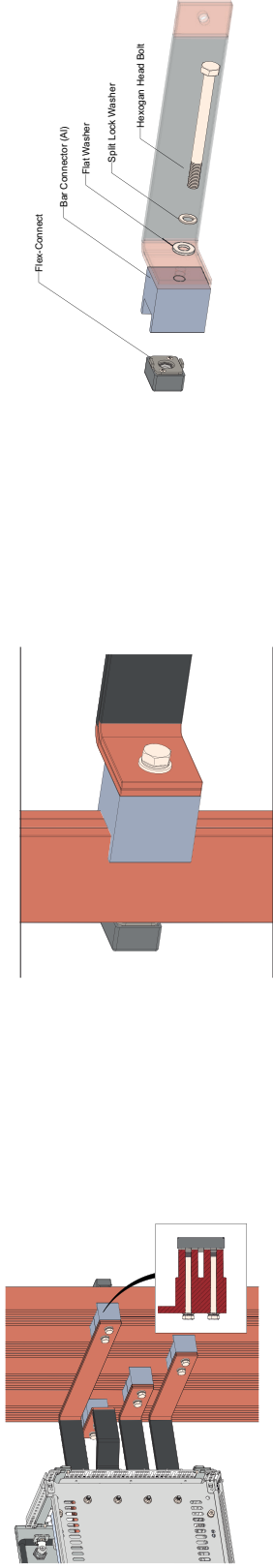

VERTICAL BUSBAR(A)	MCCB BAR SIZE		BAR CONNECTION				FLEX-CONNECT				BOLT SIZE				FLAT WASHER				SPLIT LOCK WASHER			
	TYPE	QTY	REF. NO.	PACK QTY (pcs)	REQUIRED QTY (pcs) (L1, L2, L3)	REQUIRED QTY (pcs) (N)	REF. NO.	PACK QTY (pcs)	REQUIRED QTY (pcs) (L1, L2, L3)	REQUIRED QTY (pcs) (N)	REF. NO.	PACK QTY (pcs)	REQUIRED QTY (pcs) (L1, L2, L3)	REQUIRED QTY (pcs) (N)	REF. NO.	PACK QTY (pcs)	REQUIRED QTY (pcs) (L1, L2, L3)	REQUIRED QTY (pcs) (N)	REF. NO.	PACK QTY (pcs)	REQUIRED QTY (pcs) (L1, L2, L3)	REQUIRED QTY (pcs) (N)
1620	50/10	2	1051.050	1 pc.	3	1	1035.011	40 pcs.	3	1	1053.120	20 pcs.	3	1	1035.101	20 pcs.	3	1	1035.111	20 pcs.	3	1
1620	40/10	2	1051.040	1 pc.	3	1	1035.011	40 pcs.	3	1	1053.120	20 pcs.	3	1	1035.101	20 pcs.	3	1	1035.111	20 pcs.	3	1
1620	50/10	1	1051.050	1 pc.	3	1	1035.011	40 pcs.	3	1	1053.110	20 pcs.	3	1	1035.101	20 pcs.	3	1	1035.111	20 pcs.	3	1
1620	40/10	1	1051.040	1 pc.	3	1	1035.011	40 pcs.	3	1	1053.110	20 pcs.	3	1	1035.101	20 pcs.	3	1	1035.111	20 pcs.	3	1
1620	50/5	2	1051.050	1 pc.	3	1	1035.011	40 pcs.	3	1	1053.110	20 pcs.	3	1	1035.101	20 pcs.	3	1	1035.111	20 pcs.	3	1
1620	40/5	2	1051.040	1 pc.	3	1	1035.011	40 pcs.	3	1	1053.110	20 pcs.	3	1	1035.101	20 pcs.	3	1	1035.111	20 pcs.	3	1
1620	30/5	2	1051.030	1 pc.	3	1	1035.011	40 pcs.	3	1	1053.110	20 pcs.	3	1	1035.101	20 pcs.	3	1	1035.111	20 pcs.	3	1
1620	20/5	2	1051.020	1 pc.	3	1	1035.011	40 pcs.	3	1	1053.110	20 pcs.	3	1	1035.101	20 pcs.	3	1	1035.111	20 pcs.	3	1
1620	50/5	1	1051.050	1 pc.	3	1	1035.011	40 pcs.	3	1	1053.110	20 pcs.	3	1	1035.101	20 pcs.	3	1	1035.111	20 pcs.	3	1
1620	40/5	1	1051.040	1 pc.	3	1	1035.011	40 pcs.	3	1	1053.110	20 pcs.	3	1	1035.101	20 pcs.	3	1	1035.111	20 pcs.	3	1
1620	30/5	1	1051.030	1 pc.	3	1	1035.011	40 pcs.	3	1	1053.110	20 pcs.	3	1	1035.101	20 pcs.	3	1	1035.111	20 pcs.	3	1
1620	20/5	1	1051.020	1 pc.	3	1	1035.011	40 pcs.	3	1	1053.110	20 pcs.	3	1	1035.101	20 pcs.	3	1	1035.111	20 pcs.	3	1

● Please compare the required quantities with the packs of ordering codes.



5.2 VERTICAL BUSBAR CONNECTION KIT (1350A-2300A)

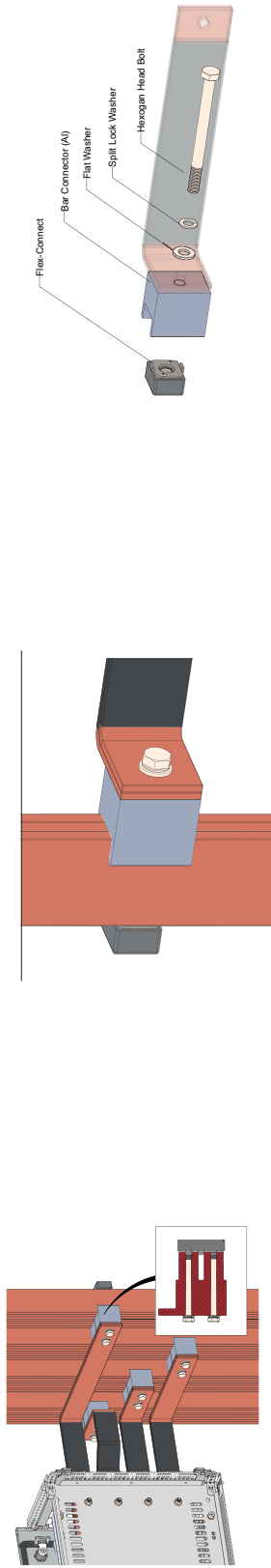

VERTICAL BUSBAR(A)	MCCB BAR SIZE		BAR CONNECTION				FLEX-CONNECT				BOLT SIZE				FLAT WASHER				SPLIT LOCK WASHER							
	TYPE	QTY	REF. NO.	PACK QTY. (pcs)	REQUIRED QTY. (pcs) (L1, L2, L3)	REQUIRED QTY. (pcs) (N)	REF. NO.	PACK QTY. (pcs)	REQUIRED QTY. (pcs) (L1, L2, L3)	REQUIRED QTY. (pcs) (N)	REF. NO.	PACK QTY. (pcs)	REQUIRED QTY. (pcs) (L1, L2, L3)	REQUIRED QTY. (pcs) (N)	REF. NO.	PACK QTY. (pcs)	REQUIRED QTY. (pcs) (L1, L2, L3)	REQUIRED QTY. (pcs) (N)	REF. NO.	PACK QTY. (pcs)	REQUIRED QTY. (pcs) (L1, L2, L3)	REQUIRED QTY. (pcs) (N)				
1350	50/10	2	1051.050	1 pc.	3	1	1085.011	40 pcs.	3	1	1053.110	20 pcs.	3	1	1085.101	20 pcs.	3	1	1035.111	20 pcs.	3	1	1035.111	20 pcs.	3	1
1350	40/10	2	1051.040	1 pc.	3	1	1085.011	40 pcs.	3	1	1053.110	20 pcs.	3	1	1085.101	20 pcs.	3	1	1035.111	20 pcs.	3	1	1035.111	20 pcs.	3	1
1350	50/10	1	1051.050	1 pc.	3	1	1085.011	40 pcs.	3	1	1053.100	20 pcs.	3	1	1085.101	20 pcs.	3	1	1035.111	20 pcs.	3	1	1035.111	20 pcs.	3	1
1350	40/10	1	1051.040	1 pc.	3	1	1085.011	40 pcs.	3	1	1053.100	20 pcs.	3	1	1085.101	20 pcs.	3	1	1035.111	20 pcs.	3	1	1035.111	20 pcs.	3	1
1350	50/5	2	1051.050	1 pc.	3	1	1085.011	40 pcs.	3	1	1053.100	20 pcs.	3	1	1085.101	20 pcs.	3	1	1035.111	20 pcs.	3	1	1035.111	20 pcs.	3	1
1350	40/5	2	1051.040	1 pc.	3	1	1085.011	40 pcs.	3	1	1053.100	20 pcs.	3	1	1085.101	20 pcs.	3	1	1035.111	20 pcs.	3	1	1035.111	20 pcs.	3	1
1350	30/5	2	1051.030	1 pc.	3	1	1085.011	40 pcs.	3	1	1053.100	20 pcs.	3	1	1085.101	20 pcs.	3	1	1035.111	20 pcs.	3	1	1035.111	20 pcs.	3	1
1350	20/5	2	1051.020	1 pc.	3	1	1085.011	40 pcs.	3	1	1053.100	20 pcs.	3	1	1085.101	20 pcs.	3	1	1035.111	20 pcs.	3	1	1035.111	20 pcs.	3	1
1350	50/5	1	1051.050	1 pc.	3	1	1085.011	40 pcs.	3	1	1053.100	20 pcs.	3	1	1085.101	20 pcs.	3	1	1035.111	20 pcs.	3	1	1035.111	20 pcs.	3	1
1350	40/5	1	1051.040	1 pc.	3	1	1085.011	40 pcs.	3	1	1053.100	20 pcs.	3	1	1085.101	20 pcs.	3	1	1035.111	20 pcs.	3	1	1035.111	20 pcs.	3	1
1350	30/5	1	1051.030	1 pc.	3	1	1085.011	40 pcs.	3	1	1053.100	20 pcs.	3	1	1085.101	20 pcs.	3	1	1035.111	20 pcs.	3	1	1035.111	20 pcs.	3	1
1350	20/5	1	1051.020	1 pc.	3	1	1085.011	40 pcs.	3	1	1053.100	20 pcs.	3	1	1085.101	20 pcs.	3	1	1035.111	20 pcs.	3	1	1035.111	20 pcs.	3	1

● Please compare the required quantities with the packs of ordering codes.



■ 5.3 VERICAL BUSBAR CONNECTION KIT (495A-1300A)

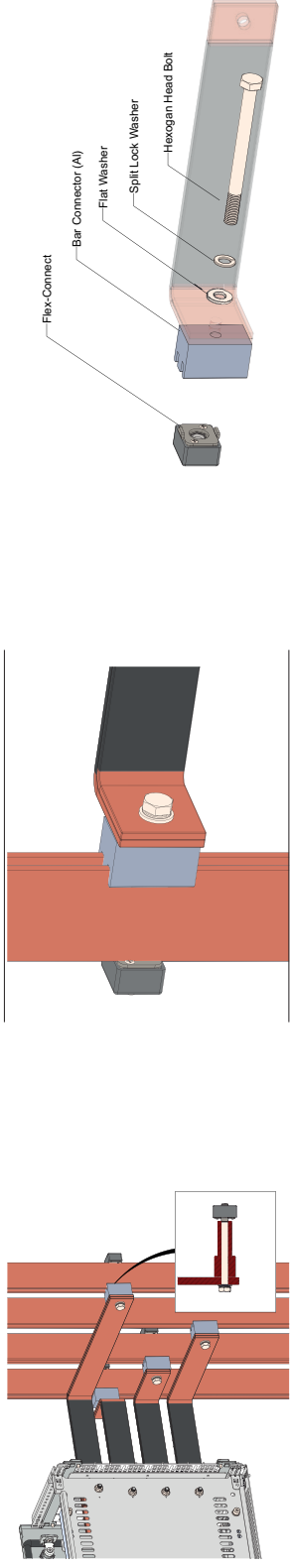

VERTICAL BUSBAR(A)	MCCB BAR SIZE		BAR CONNECTION				FLEX-CONNECT				BOLT SIZE				FLAT WASHER				SPLIT LOCK WASHER							
	TYPE	QTY	REF. NO.	PACK QTY. (pcs)	REQUIRED QTY. (pcs) (L1, L2, L3)	REQUIRED QTY. (pcs) (N)	REF. NO.	PACK QTY. (pcs)	REQUIRED QTY. (pcs) (L1, L2, L3)	REQUIRED QTY. (pcs) (N)	REF. NO.	PACK QTY. (pcs)	REQUIRED QTY. (pcs) (L1, L2, L3)	REQUIRED QTY. (pcs) (N)	REF. NO.	PACK QTY. (pcs)	REQUIRED QTY. (pcs) (L1, L2, L3)	REQUIRED QTY. (pcs) (N)	REF. NO.	PACK QTY. (pcs)	REQUIRED QTY. (pcs) (L1, L2, L3)	REQUIRED QTY. (pcs) (N)				
1300	50/10	2	1051.150	1 pc.	3	1	1035.011	40 pcs.	3	1	1053.120	20 pcs.	3	1	1035.101	20 pcs.	3	1	1035.111	20 pcs.	3	1	1035.111	20 pcs.	3	1
1300	40/10	2	1051.140	1 pc.	3	1	1035.011	40 pcs.	3	1	1053.120	20 pcs.	3	1	1035.101	20 pcs.	3	1	1035.111	20 pcs.	3	1	1035.111	20 pcs.	3	1
1300	50/10	1	1051.150	1 pc.	3	1	1035.011	40 pcs.	3	1	1053.110	20 pcs.	3	1	1035.101	20 pcs.	3	1	1035.111	20 pcs.	3	1	1035.111	20 pcs.	3	1
1300	40/10	1	1051.140	1 pc.	3	1	1035.011	40 pcs.	3	1	1053.110	20 pcs.	3	1	1035.101	20 pcs.	3	1	1035.111	20 pcs.	3	1	1035.111	20 pcs.	3	1
1300	50/5	2	1051.150	1 pc.	3	1	1035.011	40 pcs.	3	1	1053.110	20 pcs.	3	1	1035.101	20 pcs.	3	1	1035.111	20 pcs.	3	1	1035.111	20 pcs.	3	1
1300	40/5	2	1051.140	1 pc.	3	1	1035.011	40 pcs.	3	1	1053.110	20 pcs.	3	1	1035.101	20 pcs.	3	1	1035.111	20 pcs.	3	1	1035.111	20 pcs.	3	1
1300	30/5	2	1051.130	1 pc.	3	1	1035.011	40 pcs.	3	1	1053.110	20 pcs.	3	1	1035.101	20 pcs.	3	1	1035.111	20 pcs.	3	1	1035.111	20 pcs.	3	1
1300	20/5	2	1051.120	1 pc.	3	1	1035.011	40 pcs.	3	1	1053.110	20 pcs.	3	1	1035.101	20 pcs.	3	1	1035.111	20 pcs.	3	1	1035.111	20 pcs.	3	1
1300	50/5	1	1051.150	1 pc.	3	1	1035.011	40 pcs.	3	1	1053.105	20 pcs.	3	1	1035.101	20 pcs.	3	1	1035.111	20 pcs.	3	1	1035.111	20 pcs.	3	1
1300	40/5	1	1051.140	1 pc.	3	1	1035.011	40 pcs.	3	1	1053.105	20 pcs.	3	1	1035.101	20 pcs.	3	1	1035.111	20 pcs.	3	1	1035.111	20 pcs.	3	1
1300	30/5	1	1051.130	1 pc.	3	1	1035.011	40 pcs.	3	1	1053.105	20 pcs.	3	1	1035.101	20 pcs.	3	1	1035.111	20 pcs.	3	1	1035.111	20 pcs.	3	1
1300	20/5	1	1051.120	1 pc.	3	1	1035.011	40 pcs.	3	1	1053.105	20 pcs.	3	1	1035.101	20 pcs.	3	1	1035.111	20 pcs.	3	1	1035.111	20 pcs.	3	1

● Please compare the required quantities with the packs of ordering codes.



■ 5.3 VERICAL BUSBAR CONNECTION KIT (495A-1300A)

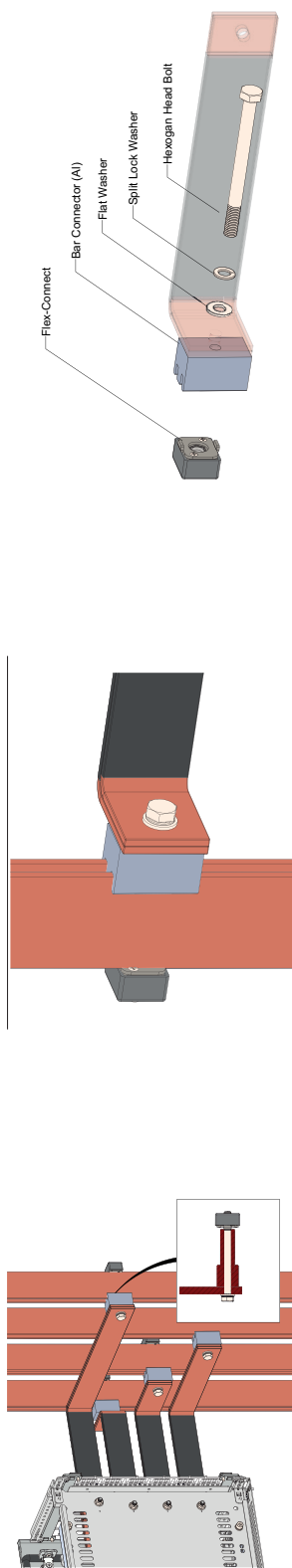

VERTICAL BUSBAR(A)	MCCB BAR SIZE		BAR CONNECTION				FLEX-CONNECT				BOLT SIZE				FLAT WASHER				SPLIT LOCK WASHER							
	TYPE	QTY	REF. NO.	PACK. QTY. (pcs)	REQUIRED QTY. (pcs) (L1, L2, L3)	REQUIRED QTY. (pcs) (N)	REF. NO.	PACK. QTY. (pcs)	REQUIRED QTY. (pcs) (L1, L2, L3)	REQUIRED QTY. (pcs) (N)	REF. NO.	PACK. QTY. (pcs)	REQUIRED QTY. (pcs) (L1, L2, L3)	REQUIRED QTY. (pcs) (N)	REF. NO.	PACK. QTY. (pcs)	REQUIRED QTY. (pcs) (L1, L2, L3)	REQUIRED QTY. (pcs) (N)	REF. NO.	PACK. QTY. (pcs)	REQUIRED QTY. (pcs) (L1, L2, L3)	REQUIRED QTY. (pcs) (N)				
1100	50/10	2	1051.150	1 pc.	3	1	1035.011	40 pcs.	3	1	1053.110	20 pcs.	3	1	1035.101	20 pcs.	3	1	1035.111	20 pcs.	3	1	1035.111	20 pcs.	3	1
1100	40/10	2	1051.140	1 pc.	3	1	1035.011	40 pcs.	3	1	1053.110	20 pcs.	3	1	1035.101	20 pcs.	3	1	1035.111	20 pcs.	3	1	1035.111	20 pcs.	3	1
1100	50/10	1	1051.150	1 pc.	3	1	1035.011	40 pcs.	3	1	1053.100	20 pcs.	3	1	1035.101	20 pcs.	3	1	1035.111	20 pcs.	3	1	1035.111	20 pcs.	3	1
1100	40/10	1	1051.140	1 pc.	3	1	1035.011	40 pcs.	3	1	1053.100	20 pcs.	3	1	1035.101	20 pcs.	3	1	1035.111	20 pcs.	3	1	1035.111	20 pcs.	3	1
1100	50/5	2	1051.150	1 pc.	3	1	1035.011	40 pcs.	3	1	1053.100	20 pcs.	3	1	1035.101	20 pcs.	3	1	1035.111	20 pcs.	3	1	1035.111	20 pcs.	3	1
1100	40/5	2	1051.140	1 pc.	3	1	1035.011	40 pcs.	3	1	1053.100	20 pcs.	3	1	1035.101	20 pcs.	3	1	1035.111	20 pcs.	3	1	1035.111	20 pcs.	3	1
1100	30/5	2	1051.130	1 pc.	3	1	1035.011	40 pcs.	3	1	1053.100	20 pcs.	3	1	1035.101	20 pcs.	3	1	1035.111	20 pcs.	3	1	1035.111	20 pcs.	3	1
1100	20/5	2	1051.120	1 pc.	3	1	1035.011	40 pcs.	3	1	1053.100	20 pcs.	3	1	1035.101	20 pcs.	3	1	1035.111	20 pcs.	3	1	1035.111	20 pcs.	3	1
1100	50/5	1	1051.150	1 pc.	3	1	1035.011	40 pcs.	3	1	1053.095	20 pcs.	3	1	1035.101	20 pcs.	3	1	1035.111	20 pcs.	3	1	1035.111	20 pcs.	3	1
1100	40/5	1	1051.140	1 pc.	3	1	1035.011	40 pcs.	3	1	1053.095	20 pcs.	3	1	1035.101	20 pcs.	3	1	1035.111	20 pcs.	3	1	1035.111	20 pcs.	3	1
1100	30/5	1	1051.130	1 pc.	3	1	1035.011	40 pcs.	3	1	1053.095	20 pcs.	3	1	1035.101	20 pcs.	3	1	1035.111	20 pcs.	3	1	1035.111	20 pcs.	3	1
1100	20/5	1	1051.120	1 pc.	3	1	1035.011	40 pcs.	3	1	1053.095	20 pcs.	3	1	1035.101	20 pcs.	3	1	1035.111	20 pcs.	3	1	1035.111	20 pcs.	3	1

● Please compare the required quantities with the packs of ordering codes.



5.3 VERICAL BUSBAR CONNECTION KIT (495A-1300A)

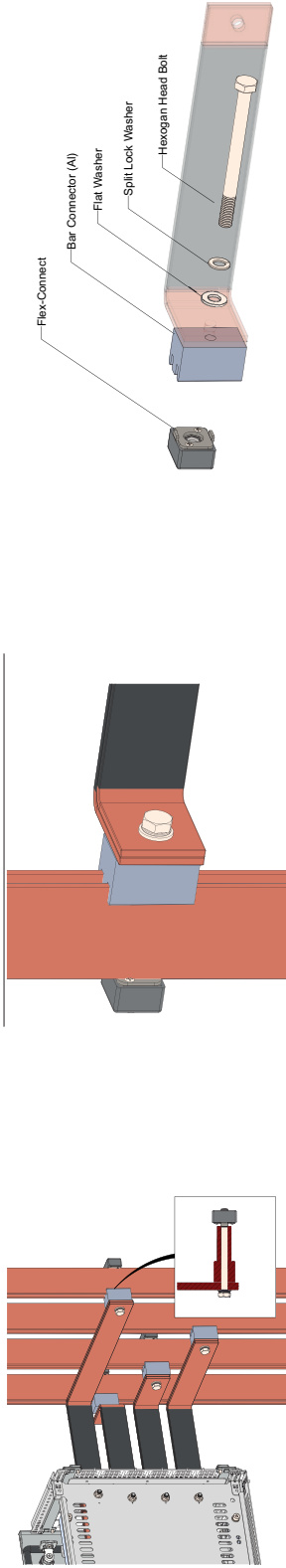

VERTICAL BUSBAR(A)	MCCB BAR SIZE		BAR CONNECTION				FLEX-CONNECT				BOLT SIZE				FLAT WASHER				SPLIT LOCK WASHER			
	TYPE	QTY	REF. NO.	PACK. QTY. (pcs)	REQUIRED QTY. (pcs.) (L1, L2, L3)	REQUIRED QTY. (pcs.) (N)	REF. NO.	PACK. QTY. (pcs)	REQUIRED QTY. (pcs.) (L1, L2, L3)	REQUIRED QTY. (pcs.) (N)	REF. NO.	PACK. QTY. (pcs)	REQUIRED QTY. (pcs.) (L1, L2, L3)	REQUIRED QTY. (pcs.) (N)	REF. NO.	PACK. QTY. (pcs)	REQUIRED QTY. (pcs.) (L1, L2, L3)	REQUIRED QTY. (pcs.) (N)	REF. NO.	PACK. QTY. (pcs)	REQUIRED QTY. (pcs.) (L1, L2, L3)	REQUIRED QTY. (pcs.) (N)
900	50/10	2	1051.150	1 pc.	3	1	1035.011	40 pcs.	3	1	1053.100	20 pcs.	3	1	1035.101	20 pcs.	3	1	1035.111	20 pcs.	3	1
900	40/10	2	1051.140	1 pc.	3	1	1035.011	40 pcs.	3	1	1053.100	20 pcs.	3	1	1035.101	20 pcs.	3	1	1035.111	20 pcs.	3	1
900	50/10	1	1051.150	1 pc.	3	1	1035.011	40 pcs.	3	1	1053.090	20 pcs.	3	1	1035.101	20 pcs.	3	1	1035.111	20 pcs.	3	1
900	40/10	1	1051.140	1 pc.	3	1	1035.011	40 pcs.	3	1	1053.090	20 pcs.	3	1	1035.101	20 pcs.	3	1	1035.111	20 pcs.	3	1
900	50/5	2	1051.150	1 pc.	3	1	1035.011	40 pcs.	3	1	1053.090	20 pcs.	3	1	1035.101	20 pcs.	3	1	1035.111	20 pcs.	3	1
900	40/5	2	1051.140	1 pc.	3	1	1035.011	40 pcs.	3	1	1053.090	20 pcs.	3	1	1035.101	20 pcs.	3	1	1035.111	20 pcs.	3	1
900	30/5	2	1051.130	1 pc.	3	1	1035.011	40 pcs.	3	1	1053.090	20 pcs.	3	1	1035.101	20 pcs.	3	1	1035.111	20 pcs.	3	1
900	20/5	2	1051.120	1 pc.	3	1	1035.011	40 pcs.	3	1	1053.090	20 pcs.	3	1	1035.101	20 pcs.	3	1	1035.111	20 pcs.	3	1
900	50/5	1	1051.150	1 pc.	3	1	1035.011	40 pcs.	3	1	1053.085	20 pcs.	3	1	1035.101	20 pcs.	3	1	1035.111	20 pcs.	3	1
900	40/5	1	1051.140	1 pc.	3	1	1035.011	40 pcs.	3	1	1053.085	20 pcs.	3	1	1035.101	20 pcs.	3	1	1035.111	20 pcs.	3	1
900	30/5	1	1051.130	1 pc.	3	1	1035.011	40 pcs.	3	1	1053.085	20 pcs.	3	1	1035.101	20 pcs.	3	1	1035.111	20 pcs.	3	1
900	20/5	1	1051.120	1 pc.	3	1	1035.011	40 pcs.	3	1	1053.085	20 pcs.	3	1	1035.101	20 pcs.	3	1	1035.111	20 pcs.	3	1

● Please compare the required quantities with the packs of ordering codes.



■ 5.3 VERICAL BUSBAR CONNECTION KIT (495A-1300A)

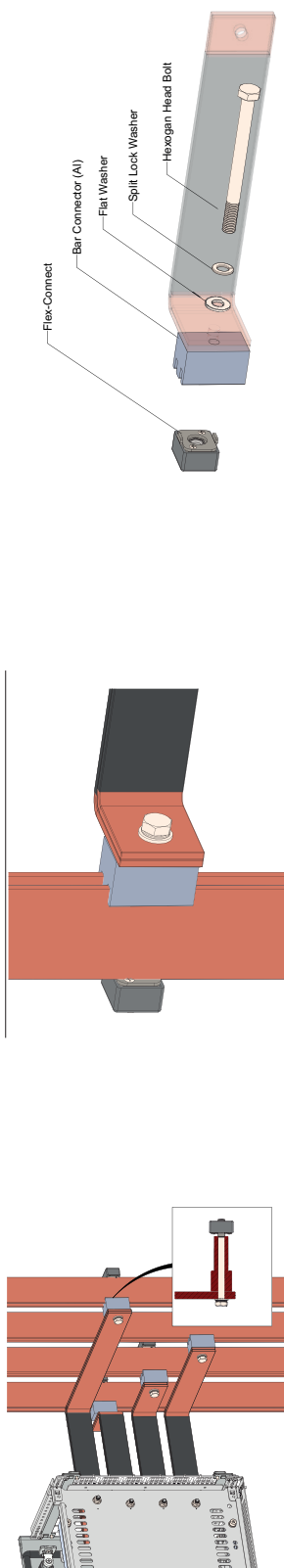

VERTICAL BUSBAR(A)	MCCB BAR SIZE		BAR CONNECTION				FLEX-CONNECT				BOLT SIZE				FLAT WASHER				SPLIT LOCK WASHER			
	TYPE	QTY	REF. NO.	PACK. QTY. (pcs)	REQUIRED QTY. (pcs) (L1, L2, L3)	REQUIRED QTY. (pcs) (N)	REF. NO.	PACK. QTY. (pcs)	REQUIRED QTY. (pcs) (L1, L2, L3)	REQUIRED QTY. (pcs) (N)	REF. NO.	PACK. QTY. (pcs)	REQUIRED QTY. (pcs) (L1, L2, L3)	REQUIRED QTY. (pcs) (N)	REF. NO.	PACK. QTY. (pcs)	REQUIRED QTY. (pcs) (L1, L2, L3)	REQUIRED QTY. (pcs) (N)	REF. NO.	PACK. QTY. (pcs)	REQUIRED QTY. (pcs) (L1, L2, L3)	REQUIRED QTY. (pcs) (N)
700	50/10	2	1051.150	1 pc.	3	1	1035.011	40 pcs.	3	1	1053.090	20 pcs.	3	1	1035.101	20 pcs.	3	1	1035.111	20 pcs.	3	1
700	40/10	2	1051.140	1 pc.	3	1	1035.011	40 pcs.	3	1	1053.090	20 pcs.	3	1	1035.101	20 pcs.	3	1	1035.111	20 pcs.	3	1
700	50/10	1	1051.150	1 pc.	3	1	1035.011	40 pcs.	3	1	1053.080	20 pcs.	3	1	1035.101	20 pcs.	3	1	1035.111	20 pcs.	3	1
700	40/10	1	1051.140	1 pc.	3	1	1035.011	40 pcs.	3	1	1053.080	20 pcs.	3	1	1035.101	20 pcs.	3	1	1035.111	20 pcs.	3	1
700	50/5	2	1051.150	1 pc.	3	1	1035.011	40 pcs.	3	1	1053.080	20 pcs.	3	1	1035.101	20 pcs.	3	1	1035.111	20 pcs.	3	1
700	40/5	2	1051.140	1 pc.	3	1	1035.011	40 pcs.	3	1	1053.080	20 pcs.	3	1	1035.101	20 pcs.	3	1	1035.111	20 pcs.	3	1
700	30/5	2	1051.130	1 pc.	3	1	1035.011	40 pcs.	3	1	1053.080	20 pcs.	3	1	1035.101	20 pcs.	3	1	1035.111	20 pcs.	3	1
700	20/5	2	1051.120	1 pc.	3	1	1035.011	40 pcs.	3	1	1053.080	20 pcs.	3	1	1035.101	20 pcs.	3	1	1035.111	20 pcs.	3	1
700	50/5	1	1051.150	1 pc.	3	1	1035.011	40 pcs.	3	1	1053.075	20 pcs.	3	1	1035.101	20 pcs.	3	1	1035.111	20 pcs.	3	1
700	40/5	1	1051.140	1 pc.	3	1	1035.011	40 pcs.	3	1	1053.075	20 pcs.	3	1	1035.101	20 pcs.	3	1	1035.111	20 pcs.	3	1
700	30/5	1	1051.130	1 pc.	3	1	1035.011	40 pcs.	3	1	1053.075	20 pcs.	3	1	1035.101	20 pcs.	3	1	1035.111	20 pcs.	3	1
700	20/5	1	1051.120	1 pc.	3	1	1035.011	40 pcs.	3	1	1053.075	20 pcs.	3	1	1035.101	20 pcs.	3	1	1035.111	20 pcs.	3	1

● Please compare the required quantities with the packs of ordering codes.



5.3 VERICAL BUSBAR CONNECTION KIT (495A-1300A)

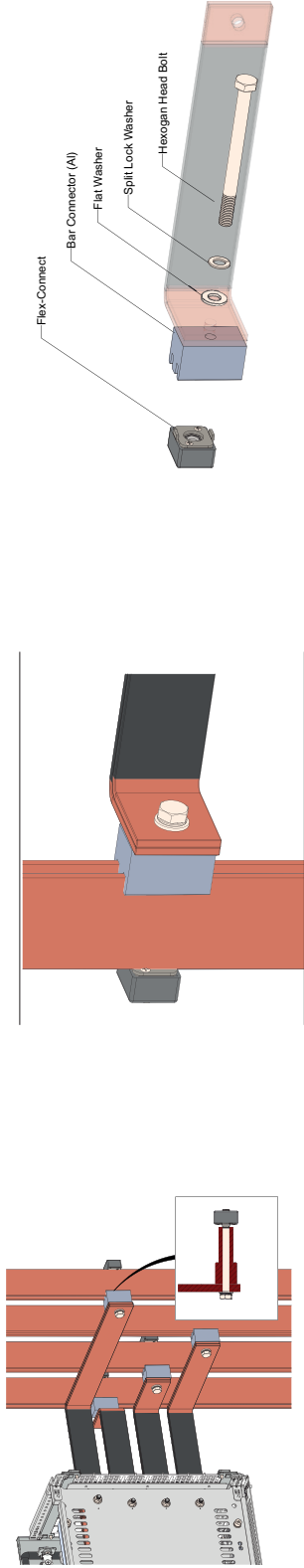

VERTICAL BUSBAR(A)	MCCB BAR SIZE		BAR CONNECTION				FLEX-CONNECT				BOLT SIZE				FLAT WASHER				SPLIT LOCK WASHER							
	TYPE	QTY	REF. NO.	PACK. QTY. (pcs)	REQUIRED QTY. (pcs) (L1, L2, L3)	REQUIRED QTY. (pcs) (N)	REF. NO.	PACK. QTY. (pcs)	REQUIRED QTY. (pcs) (L1, L2, L3)	REQUIRED QTY. (pcs) (N)	REF. NO.	PACK. QTY. (pcs)	REQUIRED QTY. (pcs) (L1, L2, L3)	REQUIRED QTY. (pcs) (N)	REF. NO.	PACK. QTY. (pcs)	REQUIRED QTY. (pcs) (L1, L2, L3)	REQUIRED QTY. (pcs) (N)	REF. NO.	PACK. QTY. (pcs)	REQUIRED QTY. (pcs) (L1, L2, L3)	REQUIRED QTY. (pcs) (N)				
495	50/10	2	1051.150	1 pc.	3	1	1035.011	40 pcs.	3	1	1035.080	20 pcs.	3	1	1035.101	20 pcs.	3	1	1035.111	20 pcs.	3	1	1035.111	20 pcs.	3	1
495	40/10	2	1051.140	1 pc.	3	1	1035.011	40 pcs.	3	1	1035.080	20 pcs.	3	1	1035.101	20 pcs.	3	1	1035.111	20 pcs.	3	1	1035.111	20 pcs.	3	1
495	50/10	1	1051.150	1 pc.	3	1	1035.011	40 pcs.	3	1	1053.070	20 pcs.	3	1	1035.101	20 pcs.	3	1	1035.111	20 pcs.	3	1	1035.111	20 pcs.	3	1
495	40/10	1	1051.140	1 pc.	3	1	1035.011	40 pcs.	3	1	1053.070	20 pcs.	3	1	1035.101	20 pcs.	3	1	1035.111	20 pcs.	3	1	1035.111	20 pcs.	3	1
495	50/5	2	1051.150	1 pc.	3	1	1035.011	40 pcs.	3	1	1053.070	20 pcs.	3	1	1035.101	20 pcs.	3	1	1035.111	20 pcs.	3	1	1035.111	20 pcs.	3	1
495	40/5	2	1051.140	1 pc.	3	1	1035.011	40 pcs.	3	1	1053.070	20 pcs.	3	1	1035.101	20 pcs.	3	1	1035.111	20 pcs.	3	1	1035.111	20 pcs.	3	1
495	30/5	2	1051.130	1 pc.	3	1	1035.011	40 pcs.	3	1	1053.070	20 pcs.	3	1	1035.101	20 pcs.	3	1	1035.111	20 pcs.	3	1	1035.111	20 pcs.	3	1
495	20/5	2	1051.120	1 pc.	3	1	1035.011	40 pcs.	3	1	1053.070	20 pcs.	3	1	1035.101	20 pcs.	3	1	1035.111	20 pcs.	3	1	1035.111	20 pcs.	3	1
495	50/5	1	1051.150	1 pc.	3	1	1035.011	40 pcs.	3	1	1053.065	20 pcs.	3	1	1035.101	20 pcs.	3	1	1035.111	20 pcs.	3	1	1035.111	20 pcs.	3	1
495	40/5	1	1051.140	1 pc.	3	1	1035.011	40 pcs.	3	1	1053.065	20 pcs.	3	1	1035.101	20 pcs.	3	1	1035.111	20 pcs.	3	1	1035.111	20 pcs.	3	1
495	30/5	1	1051.130	1 pc.	3	1	1035.011	40 pcs.	3	1	1053.065	20 pcs.	3	1	1035.101	20 pcs.	3	1	1035.111	20 pcs.	3	1	1035.111	20 pcs.	3	1
495	20/5	1	1051.120	1 pc.	3	1	1035.011	40 pcs.	3	1	1053.065	20 pcs.	3	1	1035.101	20 pcs.	3	1	1035.111	20 pcs.	3	1	1035.111	20 pcs.	3	1

• Please compare the required quantities with the packs of ordering codes.

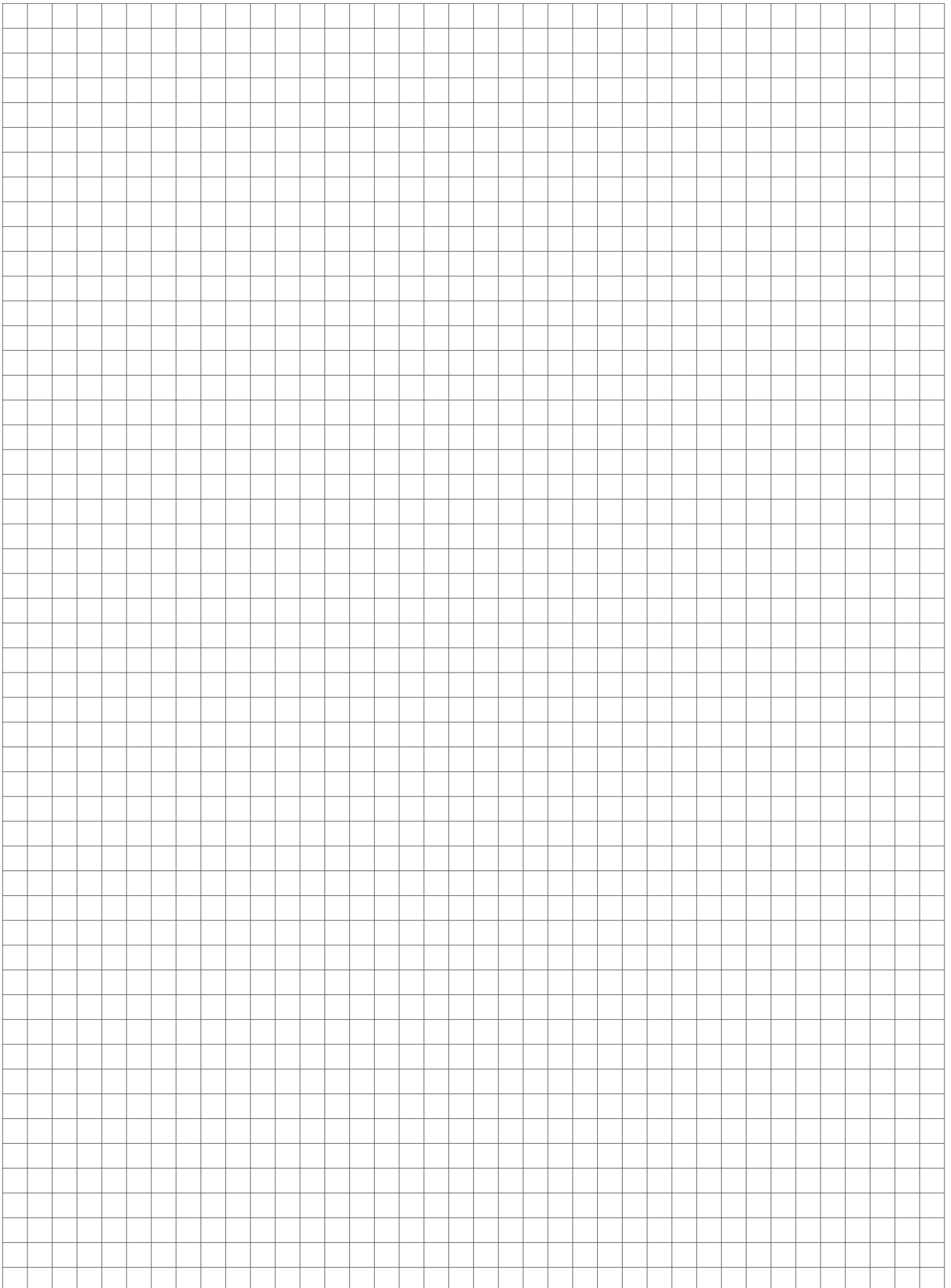

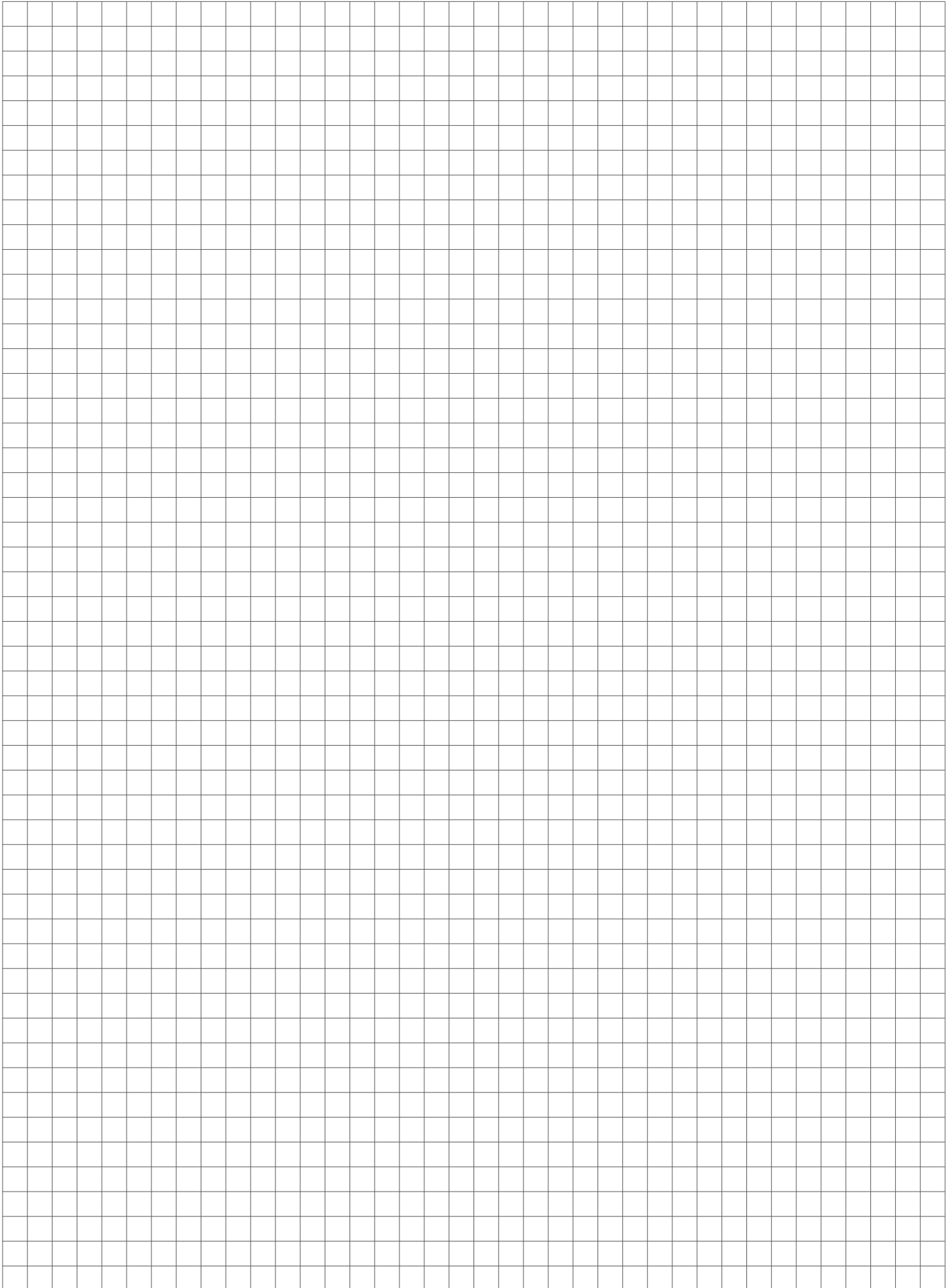

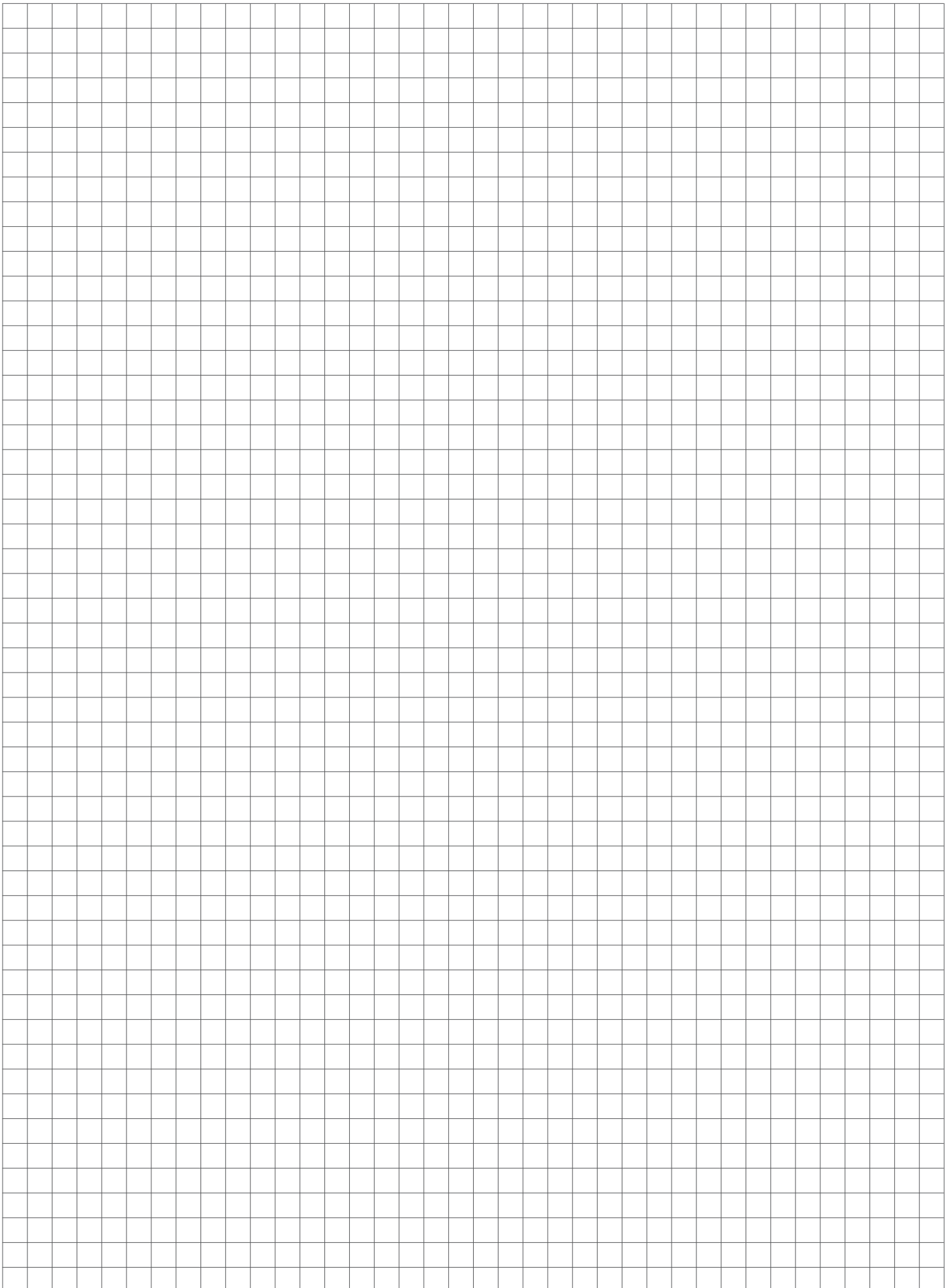



PDS
UPGRADE THE POWER